



27 years of Seedology

We do not follow trend, we follow people.

We do not create lighting, we create happiness.

We do not light up houses, we light up dreams.



SEEDDESIGN

SEEDDESIGN has been engaged in lighting design ever since 1991. It is a name after Simplicity, Elegance, Eternity and Delight. The simplicity embraces a sophistication of thought and workmanship. Without unnecessary extra feature & busy decorations, its reduced sculptural approach plays on classic and postmodern design iconography. As far as user scenario is concerned, SEEDDESIGN products always package with exclusive devices to enable users to cleverly interact with lightings. Thanks to extraordinary craftsmen and our solid mechanical engineers, SEEDDESIGN creates intriguing and practical illuminations that go well in either residential or commercial spaces. Every artistic piece is made by passion, and carried out from strict criteria. SEEDDESIGN aspires to light up joys in life and desires to challenge users' perceptions toward texture and lighting.

源自 1991 年，一位青年對燈光的想像與創作的熱情。簡單細緻的美，不容多餘線條或綴飾，來擾亂光與影的層次交迭；恰到好處的俐落，優雅地於空間中展現獨特而不譁眾的姿態。對於「燈」，我們不僅想創造視覺上的美感，更希望挑戰既有的認知，持續創新材質與結構上的運用，熱絡人與燈之間的互動關係。

DESIGNERS



Chen, Chao Cheng
陳昭成

ARCHER/ CASTLE/ DOME/ MIST
MOAI/ LALU+/ PLANET



Li, Hui Lun
李慧倫

CARRY/ CONCOM/ NUMEN
LING/ QIN/ ZHE



Wang, Chung Cheng
王崇政

SALUTE

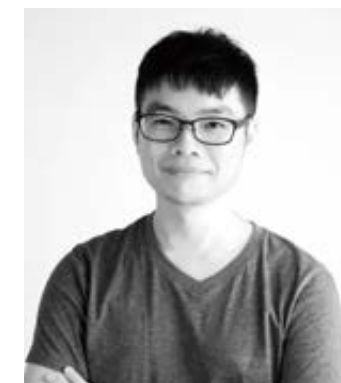

Kuo, Keng Dian
郭庚典

MUMU



Chang, Ting Ting
張滄滄

DORA

INDEX



Collection

			Table	Floor	Wall	Pendant	Ceiling
08	APOLLO 阿波羅	NEW	T	F	W	P	C
12	ARCHER 射手座		T	F	W	P	C
14	CARRY 盛		T	F	W	P	C
16	CASTLE 堡壘	💧	T	F	W	P	C
24	ROCK 浮岩	NEW	T	F	W	P	C
25	SWING 搖曳	NEW	T	F	W	P	C
26	MERMAID 花嫁	NEW	T	F	W	P	C
28	CONCOM 相伴		T	F	W	P	C
29	CHINA 閣		T	F	W	P	C
30	CHINA LED 閣LED	NEW	T	F	W	P	C
34	CLOUD 雲朵	NEW	T	F	W	P	C
35	DODO 嘟嘟鳥		T	F	W	P	C
36	DOBI 多比		T	F	W	P	C
40	DAMO 達摩		T	F	W	P	C
44	DOVE 蒼穹		T	F	W	P	C
46	DORA 朵拉	NEW	T	F	W	P	C
52	GLACIER 冰河		T	F	W	P	C
53	HELIO 日晷	NEW	T	F	W	P	C
54	HERCULES 海克力士	NEW	T	F	W	P	C
58	ICE 晶采		T	F	W	P	C
59	KAZOKU 家族		T	F	W	P	C
60	JOJO LED 悠悠LED	NEW	T	F	W	P	C

Collection

			Table	Floor	Wall	Pendant	Ceiling
62	LAITO 光	NEW	T	F	W	P	C
64	LAITO MINI 微光	NEW	T	F	W	P	C
66	LAITO GENTLE 紳光	NEW	T	F	W	P	C
68	LAITO OPAL 琥珀光	NEW	T	F	W	P	C
72	RE-LALU 光華島	NEW	T	F	W	P	C
74	LALU+ 拉魯		T	F	W	P	C
78	LALU+ LED 拉魯LED	NEW	T	F	W	P	C
82	LING 檣	NEW	T	F	W	P	C
86	MIST 嵐		T	F	W	P	C
88	MOAI 摩艾	NEW	T	F	W	P	C
92	MUMU 目木	NEW	T	F	W	P	C
96	NEWTON 蘋果		T	F	W	P	C
97	NUMEN 精靈		T	F	W	P	C
98	PENSÉE 思想		T	F	W	P	C
99	SNOWFLAKE 雪花		T	F	W	P	C
100	PLANET 行星		T	F	W	P	C
104	QIN 沁		T	F	W	P	C
106	SALUTE 舉杯		T	F	W	P	C
108	T1 T1	💧	T	F	W	P	C
109	TICKTOCK 滴答		T	F	W	P	C
110	ZHE 柘		T	F	W	P	C
112	TECHNICAL DATA 索引						



APOLLO

The simple yet eye-catching APOLLO aims to make a big impression among space. The huge shade embraces and sheds the light at the same time; while the LED module is integrated behind the metal cap, preventing the light from being visible and causing glare. This collection offers pendant and floor lamp. The floor lamp is married with wooden tripods along with a touch-dimmer device, allowing users to enjoy flexible modes like being in nature.



HERCULES

The HERCULES series was launched as tribute to the strong, courageous character of Greek mythology. Featuring brilliant mechanical structures while maintaining the essential spirit of design, the HERCULES provides a stunning balance between form and function. Users can turn on and dim the LED light via a swirling switch, adjust the rotating shade and create a perfectly placed arc with the simple move of a lever. The Hercules is strong yet flexible enough to fit your specific lighting needs.



LAITO GENTLE

The LAITO Gentle is inspired by modern gentlemen who is in particular reckoned as properly-dressed, caring for details along with exquisite taste. This is a design of which takes full advantage of the mechanical intelligence and vintage aesthetics. Spinning the rotary switch allows to find the suitable height, together with the lampshade provides a multi-direction adjustment function. It is elegantly matched with refined hues to perform as the best mate every man should keep.



LAITO OPAL

In keeping with the LAITO series vintage heritage the LAITO Opal adds softness to the classic, streamlined shape, evoking a subdued glow of years gone by. It can be perfectly positioned for your task at hand. As with the rest of the Laito series aesthetic is never compromised by function.



LING

LING is a harmonious mingle of minimalism and nostalgia design which is inspired by patterned metal-fence used to be built around balconies and windows in early Taiwan. The copper/ brass glow elegantly connects glass and metal shade. Through inner reflection of embedded LED light source, the adorable lamp impressively creates double ambience in one single fitting.

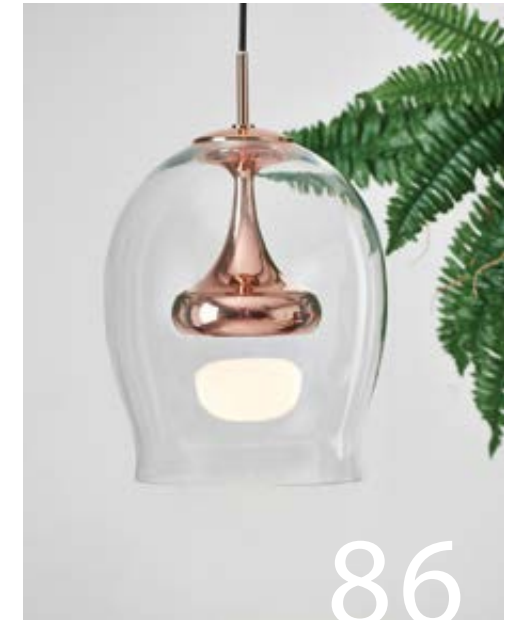

MOAI

When illuminated the MOAI provides an atmospheric, ambient glow as light moves through the sphere and bounces off the clear glass shade creating a unique egg-shaped reflection. A beautiful silhouette reminiscent of the stone statues of Easter Island, the MOAI is dynamic whether on or off.

NEW LAUNCHES

APOLLO 阿波羅

By Chen, Chao Cheng 陳昭成, 2017



The simple yet eye-catching APOLLO aims to make a big impression among space. The huge shade embraces and sheds the light at the same time; while the LED module is integrated behind the metal cap, preventing the light from being visible and causing glare. This collection offers pendant and floor lamp. The floor lamp is married with wooden tripods along with a touch-dimmer device, allowing users to enjoy flexible modes like being in nature.

晨間的日光，灑下初醒氣息，窗台外大把光線蔓延室內，輕聲喚起睡意朦朧的人們。濃郁的咖啡香，迴繞在摩卡壺邊滋滋作響，親手烹製的朝食，餵養渴求新鮮的靈魂，揀本雜誌翻了翻，一頁頁文字拉緩時間的步伐，用簡單的節奏，勾勒心中想望的舒愜光景。

象徵「太陽」的 APOLLO 阿波羅系列，大片 LED 光源綻放朝陽般的和煦，營造安閒的生活空間。其中，立燈具備漸進調光功能，無論是明亮晨光、午後斜陽、或是優雅月光，盡收於一室日常。

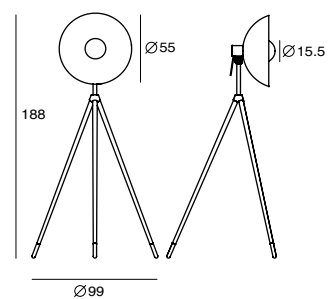

Apollo Floor

SLD-3655MF
LED 17W (2700K, CRI 90, 1360lm)
Shade rotatable
Adaptor driver
Touch dimmer switch
Black textile cord

Materials : aluminum, beech
Color : matt black + wood tripod



matt black



matt black +
copper core



matt white



matt white +
matt brass cap

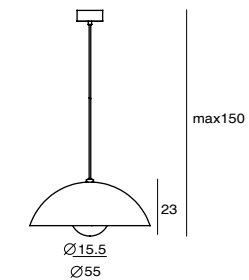

Apollo Pendant

SLD-3655MP
LED 21W (2700K, CRI 90, 1680lm)
Built-in driver
Black textile wire

Material : aluminum

Color : matt black
matt white
matt black + copper cap
matt white + matt brass cap

Canopy : Type A40, same as shade color
Back Plate : Type A23

ARCHER 射手座

By Chen, Chao Cheng 陳昭成, 2012



ARCHER is one of the brightest constellations in a summer night. The solid bow arm is constructed with zelkova wood. Beech is a fine grained woods from the Elm family. Its design resonate a combative spirit. The bowstring is conveniently created for easy adjustment in the lamps arm. Its base is solidly constructed with metal. A centaur is always depicted with head, arms, and torso of a human, and body and legs of a horse. He is an elegant and wise archer who can be a reliable guardian.

射手座是夏日夜空中最醒目的星座之一。人頭馬身，是充滿智慧與優雅的弓箭手。以紋理流暢的櫟木作為堅固弓臂，柔和了弓箭的肅殺之氣，弓弦則能調整圓弧曲線的角度，配合您的姿態，讓一體成形的射手座成為您可依靠的守護者。

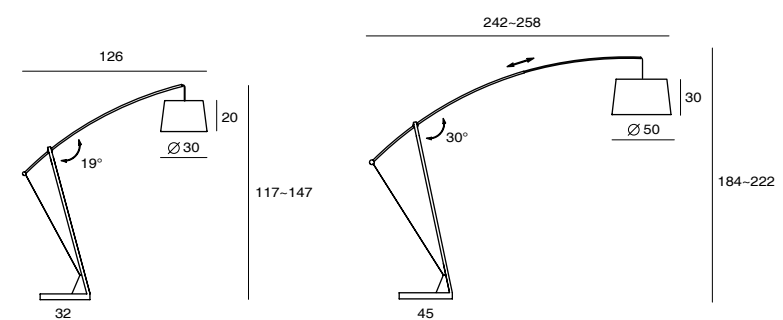

Archer Floor

SQ-703FR
E27 1 x Max 46W
In-line on/off switch
Black textile wire

Materials : fabric, steel, beech
Color : beech + matt black
Remark : w/o diffuser

Archer Floor Mega

SQ-603FLR
E27 3 x Max 46W
In-line on/off switch
Black textile wire

Materials : fabric, steel, beech, acrylic (diffuser)
Color : beech + matt black
Remark : w/ diffuser

CARRY 盛

By Li, Hui Lun 李慧倫, 2012



Carry Floor

CARRY marries utility with design. Not only is the CARRY chic enough to spruce up any space it also serves as a great light source, it is strategically designed with a plate to hold daily essentials such as keys and coins. The CARRY helps you achieve meticulous order in a fast paced society, a must-have for any modern lifestyle. The lamp comes equipped with a USB adapter, specially designed for our technology enriched way of life.

CARRY 的靈感，來自繁忙的生活中想帶給您一絲貼心。除了以節能光源點亮並點綴空間外，更多了實用便利性：木質圓盤能讓您隨意放置暫時不知該放哪裡的各式小物。另外，還有特別為商務人士所設計的 USB 插槽，可讓您的智慧型手機或平板電腦安心地放置並充電，或者，插上 USB 喇叭，煮杯咖啡，悠閒地享受音樂。在 CARRY 沉穩的霧面烤漆外表下，靜靜整理繁忙人生中的瑣碎。



Carry Table



matt black + red tray



matt white + beech tray

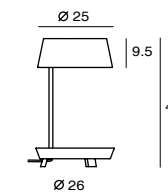

Carry Table
SQ-6353MDU
E27 1 x Max 46W
On/off rocker switch
USB charger

Materials : steel, beech
Color : matt black + red tray w/ red textile cord
matt white + beech tray w/ black textile cord

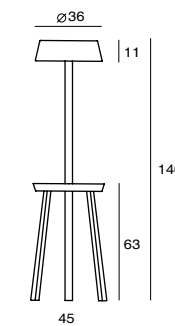

Carry Floor
SQ-6350MFU
E27 2 x Max 46W
On/off rocker switch
USB charger

Materials : steel, beech
Color : matt black + red tray w/ red textile cord
matt white + beech tray w/ black textile cord



CASTLE FAMILY

The concrete- made CASTLE lamps has took two years on plenty of studies and trials. In 2008 we were proud to be the pioneer of presenting this much-welcomed collections. Ever since its first launch, the CASTLE has been an iconic family among all products. It comes with multiple choices in pendants, and wall lamp for outdoor (IP65).

耗時兩年研發，終於在 2008 年成功推出國際上第一件水泥燈飾 CASTLE。保留了水泥的原始紋理，同時呈現細緻觸感，並在中大型尺寸的材料中添加特殊材質，確保水泥的密合度及安全性。CASTLE 不僅顛覆燈具材料的印象，亦賦予原本樸實平凡的水泥嶄新的生命力。有多款造型吊燈，及戶外壁燈可供選擇。



CASTLE Pendant XS



CASTLE Pendant CONE XS / CASTLE Pendant CONE S / CASTLE Pendant BELL XS / CASTLE Pendant BELL S

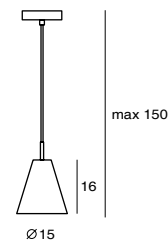

Castle Pendant CONE XS

SQ-187CP
E14 1 x Max 25W
Gray textile wire

Materials : concrete, aluminum
Color : concrete
Canopy : Type A, chrome
Back Plate : Type A

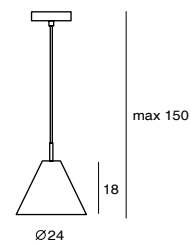

Castle Pendant CONE S

SQ-185CP
E27 1 x Max 46W
Gray textile wire

Materials : concrete, aluminum
Color : concrete
Canopy : Type A, chrome
Back Plate : Type A

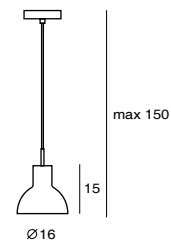

Castle Pendant BELL XS

SQ-3163CP
E14 1 x Max 25W
Ribbed reflector
Gray textile wire

Materials : concrete, aluminum
Color : concrete
Canopy : Type A, chrome
Back Plate : Type A

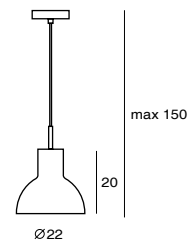

Castle Pendant BELL S

SQ-3164CP
E27 1 x Max 46W
Ribbed reflector
Gray textile wire

Materials : concrete, aluminum
Color : concrete
Canopy : Type A, chrome
Back Plate : Type A



CASTLE Pendant XS



Castle Pendant M

Photo Credit : More-in Interior Design

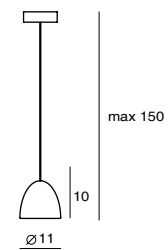

Castle Pendant XS

SG-623CP
G9 1 x Max 25W
Gray textile wire

Materials : concrete, aluminum
Color : concrete
Canopy : Type A, chrome
Back Plate : Type A

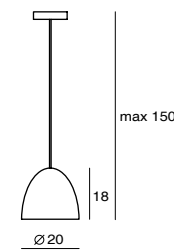

Castle Pendant S

SQ-7131CP
E27 1 x Max 46W
Ribbed reflector
Gray textile wire

Materials : concrete, aluminum
Color : concrete
Canopy : Type A, chrome
Back Plate : Type A

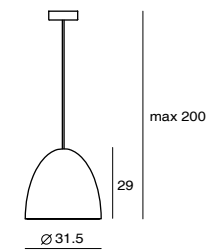

Castle Pendant M

SQ-7132CP
E27 1 x Max 46W
Ribbed reflector, bulb cover
Gray textile wire

Materials : concrete, steel, aluminum
Color : concrete
Canopy : Type A4, chrome
Back Plate : Type B2

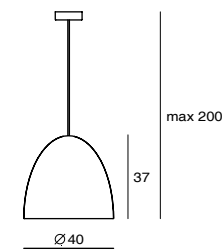

Castle Pendant L

SQ-7133CP
E27 1 x Max 46W
Ribbed reflector, bulb cover
Gray textile wire

Materials : concrete, steel, aluminum
Color : concrete
Canopy : Type A4, chrome
Back Plate : Type B2

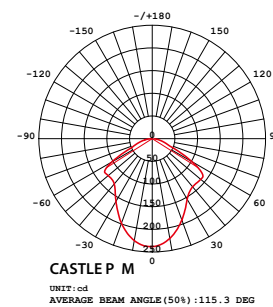



Castle Wall R LED

Photo Credit : More-in Interior Design



Castle Wall S LED Outdoor

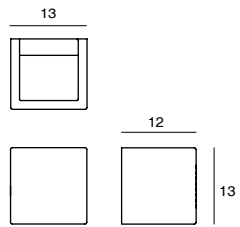

Castle Wall S LED Outdoor
SLD-7033CWO
LED 5W (3000K, CRI 90, 440lm)
Built-in driver

Materials : concrete, steel
Color : concrete
Canopy : Type B15, shiny white
Back Plate : A30

IP 65

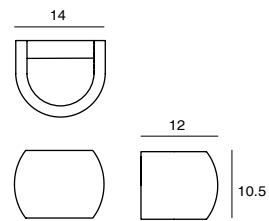

Castle Wall R LED Outdoor
SLD-7034CWO
LED 5W (3000K, CRI 90, 440lm)
Built-in driver

Materials : concrete, steel
Color : concrete
Canopy : Type B15, shiny white
Back Plate : A30

IP 65

Castle Wall S LED
SLD-7033CW
LED 5W (3000K, CRI 90, 440lm)
Built-in driver

Materials : concrete, steel
Color : concrete
Canopy : Type B14, shiny white
Back Plate : C2

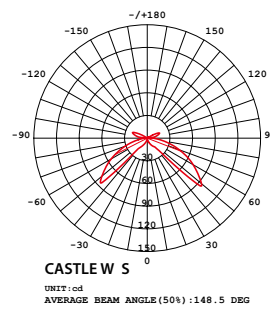

CASTLE ROCK 浮岩

By Li, Hui Lun 李慧倫, 2016



CASTLE SWING 搖曳

By Li, Hui Lun 李慧倫, 2016



Castle Pendant Swing S

The CASTLE Rock's faceted concrete shade is a geometric representation of what is found in nature. The matt concrete exterior is contrasted by a metallic interior which reflects and amplifies the down-cast light providing a soft illumination.

延續 CASTLE 堡壘「居家守護」的印象，Castle_Rock 燈款造型厚實穩重，散發如同岩石般穩固的性格。設計師將自然融於幾何美學，以連續折線切割多邊平面，讓不規則的 2D 表面互相連結，達到 3D 空間層次的視覺效果。一盞燈點亮的，是居住者對生活的解讀，也是創作者對自然的真切崇拜。

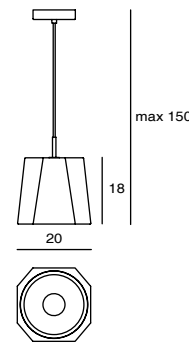

Castle Pendant Rock

SQ-2321CP
E27 1 x Max 46W
Gray textile wire

Materials : concrete, aluminum
Color : concrete
Canopy : Type A18, chrome
Back Plate : Type A

"One, two, three; one, two, three" Inspired by the movement of a dancing women's dress, the CASTLE Swing- propells a solid concrete shade to move. A simple twist in the shape gives an otherwise heavy material a lightness that evokes a sense of song and dance.

當身體隨著節拍左右搖曳，腦中分泌的多巴胺，會讓人不由自主感到放鬆愉悅。設計師從人們開懷舞動的過程得到靈感，藉由延展性高的水泥材質，捕捉這瞬間的幸福意象。CASTLE_Swing 設計過程中，如何讓水泥完美展現裙擺輕揚的狀態，是極大的挑戰。由於材質特性侷限，旋轉角度太大會脫不了膜，角度太小則顯現不出飄曳動感。在無數次來回討論後，我們終於驕傲地將象徵「單純喜悅」而造型獨一無二的 CASTLE_Swing，盤旋於居家空間之中。

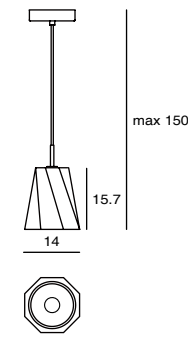

Castle Pendant Swing XS

SQ-1251CP
E14 1 x Max 25W
Gray textile wire

Materials : concrete, aluminum
Color : concrete
Canopy : Type A, chrome
Back Plate : Type A

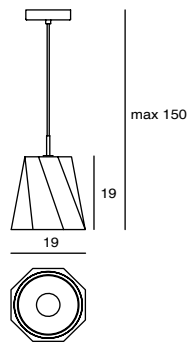

Castle Pendant Swing S

SQ-1252CP
E27 1 x Max 46W
Gray textile wire

Materials : concrete, aluminum
Color : concrete
Canopy : Type A18, chrome
Back Plate : Type A

CASTLE MERMAID 花嫁

By Li, Hui Lun 李慧倫, 2016

Inspired by evening gowns of the same name, the Mermaid pendants silhouette has captured the flowing movement of fabric in solid concrete. The Mermaid remains strong with an accent of metal defining the shade, while lending a softer and more feminine shape to the Castle series.

帶有女性意象的 CASTLE_Mermaid，為一連串洗鍊質樸的水泥系列，注入全新火花。利用異材質結合手法，Mermaid 將中間金屬腰封串接上下燈罩，為無彩度的表面帶來亮點；總共 12 摺的裙擺，更隱喻現代女性涉獵多方、擁有不同面向的獨立態度。



concrete +
matt brass ring



concrete +
satin ring

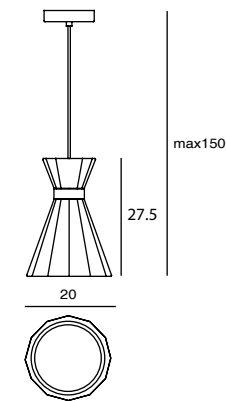

Castle Pendant Mermaid S

SQ-7121CP
E27 1 x Max 46W
Gray textile wire

Materials : concrete, steel, aluminum
Color : concrete + matt brass ring
concrete + satin ring
Canopy : Type A18, same as ring color
Back Plate : Type A

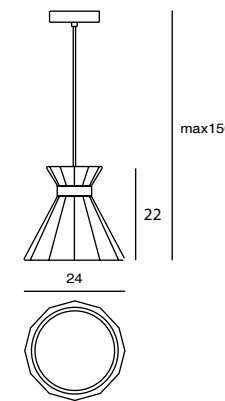

Castle Pendant Mermaid L

SQ-7122CP
E27 1 x Max 46W
Gray textile wire

Materials : concrete, steel, aluminum
Color : concrete + matt brass ring
concrete + satin ring
Canopy : Type A, same as ring color
Back Plate : Type A

COMCON 相伴

By Li, Hui Lun 李慧倫, 2009



Light and shadow are twins. Together with each other they emit fascinating changes within spaces. The design concept comes from the idea of companionship. It is believed to be the best virtue among families, and we do hope this gift reminds you of treasuring precious moments that taking place at every home.

光和影子總是形影不離，分享彼此的小祕密，這種如影隨形的親密，是「相伴」的小心機！透過具像的立影，即使沒有點亮它，依然感受它陪在你身邊。陪伴，是人與人之間最無價的禮物。



matt black



matt white

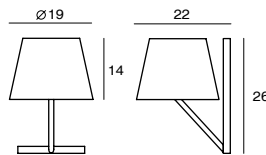

Concom Wall
SQ-513MW
E14 1 x Max 25W

Material : steel
Color : matt black
matt white
Canopy : Type N, same as shade color
Back Plate : Type N

CHINA 閣

By Chen, Chao Cheng 陳昭成, 2004



CHINA epitomizes an oriental spirit, an elder with infinite wisdom. CHINA features an impressive oil-bronzed finish with brushed copper edge. It intelligently comes with a spinning switch. Turn the base on and you will find a subtle light spinning. It is singing and celebrating the chords of the Eastern spirit.

深藏東方人文底蘊的「閣」，如同一位智者一身簡單、低調卻智慧無限。透過 DJ dimmer 的專利調光裝置，在沉穩之餘也帶入創意與幽默。不但豐富了光影變化，亦將外型簡化到極致，似乎在觸碰 DJ switch，隨著光影變化的同時，也聽見黑膠唱片轉動的聲音。

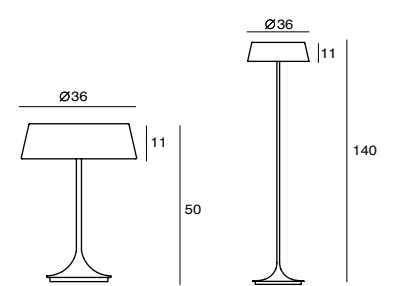

China Table
SQ-6350MDJ2
E27 2 x Max 46W
DJ dimmer
Black textile cord

Material : steel
Color : oil bronze

China Floor
SQ-6350MF-1
E27 2 x Max 46W
In-line on/off foot switch
Black textile cord

Material : steel
Color : oil bronze



CHINA LED 閣

By Chen, Chao Cheng 陳昭成, 2017

An iconic SEED design, the CHINA LED brings a classic shape into the new millennium. With a patented spinning DJ switch and immaculately crafted metal body the CHINA LED is a harmonious blend of new and old, making it a suitable lighting solution for both modern and traditional spaces.

線條外型取自清朝官帽加以反戴，CHINA LED 兼容東西美學，將內斂禪風注入現代簡約。樸實外表下，以獨家語言詮釋創意生活的個人主張。旋轉式底座兼具開關與調光功能：當使用者在轉動 DJ Base、翻玩光影變化的片刻，彷彿時空身份更改，變成 DJ 享受打碟播放音樂的樂趣。燈款使用高演色性 LED 光源，搭配過篩效果的遮光罩，整體光氛更顯細緻不刺眼。

CHINA LED 以輕薄纖細之丰姿，迎接新世代智慧的來臨，當生活旋律開始吟唱，空間和諧的溫度亦隨之流洩而出。





matt black



matt brass shade +
matt black

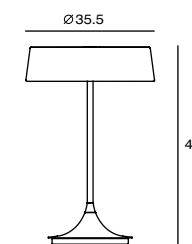

China LED Table
SLD-6354MDJ
LED 18W (2700K, CRI 90, 1900lm)
Adaptor driver
Patent DJ dimmer
Black textile cord

Material : steel
Color : matt black
matt brass shade + matt black base & tube

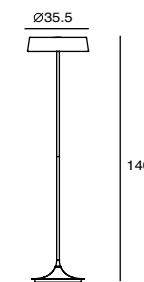

China LED Floor
SLD-6354MFE
LED 18W (2700K, CRI 90, 1900lm)
Adaptor driver
Foot dimmer
Black textile cord

Material : steel
Color : matt black
matt brass shade + matt black base & tube

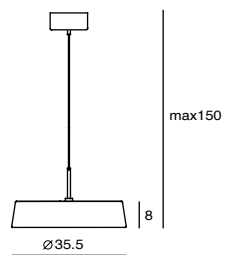

China LED Pendant
SLD-6354MP
LED 18W (2700K, CRI 90, 1900lm)
Built-in dimmable driver
Black textile wire

Material : steel
Color : matt black
matt brass
Canopy : Type A16, same as shade color
Back Plate : Type A



CLOUD 雲朵

By Chen, Chao Cheng 陳昭成, 2017

By using crafted blown glass as material, the sleek round-shaped CLOUD lamp appears an adorable scene within spaces. The shade consists of tech-forward LED module, which consumes less power and reduces inconvenience of changing bulbs from high. Lit with the CLOUD, the gentle illumination would bring a calm stress-free sensibility around.

夏日午後，窗框外的藍天白雲高掛，綿密而蓬鬆，望著望著，好想漫步那片柔軟，選朵最舒適的區塊自在躺下。挾帶瞌睡蟲的微風輕掠髮際，和諧地與慵懶的溫度沁入心懷。

CLOUD 雲朵將悠然景象帶進室內，藉由霧白玻璃圓潤的線條，營造明亮清爽的居家色系；LED 光源除了對地球友善，亦進一步解決燈泡更換的不便。今晚，蜷臥在 CLOUD 溫柔的懷裡，紀錄一夜夜的香甜夢境。

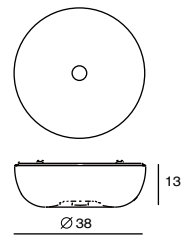

Cloud Ceiling
SLD-7938C
LED 30W (2700K, CRI 90, 940lm)
Built-in dimmable driver

Materials : mouth-blown glass, steel
Color : shiny opal + chrome
Canopy : Type A42

DODO 嘟嘟鳥

By Chen, Chao Cheng 陳昭成, 2013

Drawing back fondest memories to a character in the Alice in the Wonderland fairytale, Dodo the birds' appearance is comical yet beautiful. Inspired by his whimsical body shape, Dodo is undoubtedly the best demonstration of natural simplicity. Equipped with dip switch, the Dodo light can light up anyone's courage and adventurous mind. In addition, its adjustable shade provides ample covering and tilts at whatever angle your heart desires. Time to light a bright world of your own! Meet Dodo.

愛麗絲夢遊仙境裡，嘟嘟鳥俏皮可愛的模樣深植於腦海。DODO 具象化其身形，完美演繹極簡美學，象徵鳥喙的水滴開關，點亮住在你我內心的愛麗絲；帶著 DODO，描繪出專屬於您的異想世界，一起歷險吧！可調式燈罩的貼心設計，無論何種角度，別怕，有 DODO 在旁，為您照亮每個黑暗。



matt black copper



shiny white chrome

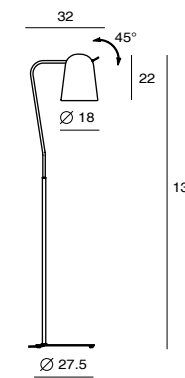

Dodo Floor
SQ-218FR
E27 1 x Max 46W
Shade rotatable
Dip switch
Black textile cord

Material : steel
Color : matt black

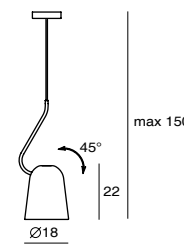

Dodo Pendant
SQ-218PS
E27 1 x Max 46W
Shade rotatable
Black textile wire

Material : steel
Color : copper
chrome
matt black
shiny white
Canopy : Type A, same as shade color
Back Plate : Type A

DOBI 多比

By Chen, Chao Cheng 陳昭成, 2015



Catering to smaller scaled spaces, the DOBI offers a more petite version of the ever so popular DODO. Besides scaling down in size, the DOBI remains true to much of the original DODO features such as the incorporation of a dip switch, elongated dome shape, and adjustable shade. For those with a tight space to work with, but unwillingness to compromise on style, the DOBI is a must have.

愛麗絲夢遊仙境裡，嘟嘟鳥俏皮可愛的模樣深植於腦海。DODO 具象化其身形，完美演繹極簡美學，象徵鳥喙的水滴開關，點亮你我內心的好奇愛麗絲；帶著 DODO，描繪出專屬於使用者的異想世界。2016 年 SEEDDESIGN 因應居家空間的不同，推出精巧版 DOBI，展現既活潑時髦又典雅的 mini chic 風格；比例縮小、功能依舊，無論何種角度，別怕，有 DODO 在旁為您照亮每個黑暗。



copper + matt black



shiny white + matt brass

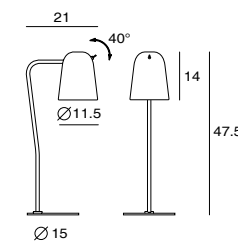

Dobi Table

SQ-2181D
E14 1 x Max 25W
Shade rotatable
Dip switch
Black textile cord

Material : steel
Color : shiny white shade & base + matt brass tube
copper shade + matt black base & tube

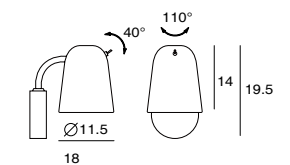

Dobi Wall

SQ-2181W
E14 1 x Max 25W
Shade rotatable
Dip switch

Material : steel
Color : shiny white shade & canopy + matt brass tube
copper shade + matt black tube & canopy
Canopy : Type A22
Black Plate : Type A6

Photo Credit : Newrtd Design



Dobi Pendant P6

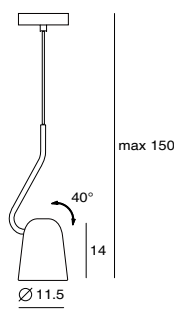

Dobi Pendant

SQ-2181P5
E14 1 x Max 25W
Shade rotatable
Black textile wire

Material : steel

Color : shiny white shade & canopy + matt brass tube
copper shade + matt black tube & canopy
matt brass shade + matt black tube & canopy
Canopy : Type A
Black Plate : Type A

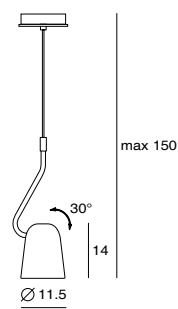

Dobi Pendant

SQ-2181PR-1
E14 1 x Max 25W
Shade rotatable
Black textile wire

Material : steel

Color : shiny white shade & canopy + matt brass tube
copper shade + matt black tube & canopy
matt brass shade + matt black tube & canopy
Canopy : Type A23
Black Plate : Type A6

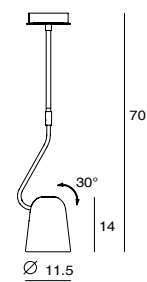

Dobi Pendant Tube 70

SQ-2181PR-70
E14 1 x Max 25W
Shade rotatable
Black textile wire

Material : steel

Color : shiny white shade & canopy + matt brass tube
copper shade + matt black tube & canopy
matt brass shade + matt black tube & canopy
Canopy : Type A23
Black Plate : Type A6

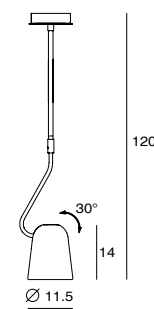

Dobi Pendant Tube 120

SQ-2181PR-120
E14 1 x Max 25W
Shade rotatable

Material : steel

Color : shiny white shade & canopy + matt brass tube
copper shade + matt black tube & canopy
matt brass shade + matt black tube & canopy
Canopy : Type A23
Black Plate : Type A6

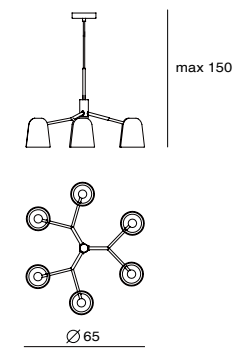

Dobi Pendant P6

SQ-2181P6
E14 6 x Max 25W
Shade rotatable
Black textile wire

Material : steel

Color : shiny white shade + matt black body
copper + matt black body
Canopy : Type A
Black Plate : Type A

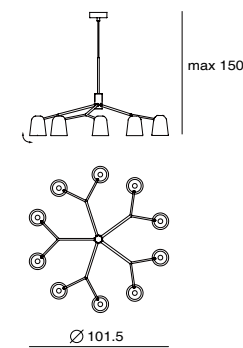

Dobi Pendant P10

SQ-2181P10
E14 10 x Max 25W
Shade rotatable
Black textile wire

Material : steel

Color : shiny white shade + matt black body
copper + matt black body
Canopy : Type A11
Black Plate : Type B2



copper +
matt black



shiny white +
matt black



DAMO 達摩

By Chen, Chao Cheng 陳昭成, 2013

A legendary wise man named Bodhidharma spent nine years in quest to uncover the truth to Buddhism. He was so strong-minded that nothing could challenge his determination. In reverence to the legendary sage, we would like to demonstrate his dynamic spirit and unwavering attitude. We hereby unveil DAMO. DAMO not only crafts a sense of serenity it also instills utmost vitality through its brightness, clarifying your innermost thoughts when needed.

相傳達摩面壁苦修佛法九年，因其屹立不倒，尊稱為不倒翁。Damo 曲線間流露沈穩感，誠如達摩大師洒然挺立於山間，堅毅而不拔；可調式燈罩的設計，與不倒翁搖動仍立定於原地的概念，有著異曲同工之妙。Damo 不僅於居家環境中散發靜謐光氛，更展現其沈穩而內斂的生命力。



matt black



chrome



copper

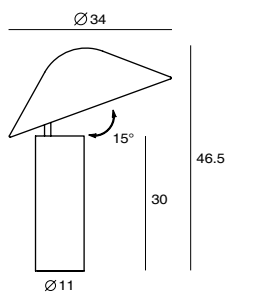

Damo Table Simple
SQ-339MDRS-1
E27 1 x Max 46W
Shade rotatable
On/off push switch
Black textile cord

Material : steel
Color : copper
chrome
matt black



matt black



matt brass



copper

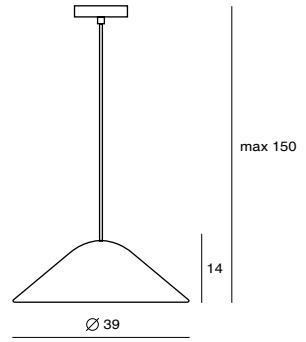

Damo Pendant
 SQ-339MP
 E27 2 x Max 46W
 Black textile wire

Material : steel, glass (diffuser)
 Color : copper
 matt brass
 matt black
 Canopy : Type A, same as shade color
 Back Plate : Type A

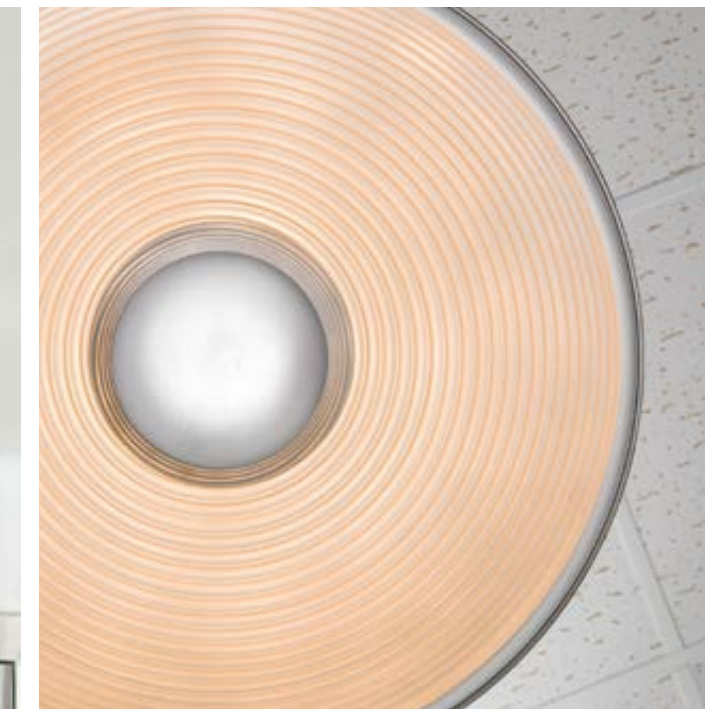

DOME 蒼穹

By Chen, Chao Cheng 陳昭成, 2005

DOME fuses simplistic ideologies with precise craftsmanship. Balanced with a classic silhouette, the DOME features a vast lampshade embedded with a swirling aluminum reflector to soften the illuminance. Apart from that, in order to avoid the uncomfortable experience caused by glare, there is an easy-to-turn cover beneath the bulb. DOME goes well in both residential and commercial areas.

越簡單的外型藏著越不簡單的工藝。穹頂的半圓型燈罩，散發出簡鍊低調性格。同心圓鋁反射罩，底部的燈泡蓋遮住刺眼的光線，帶來室內空間溫和平靜的喜悅。

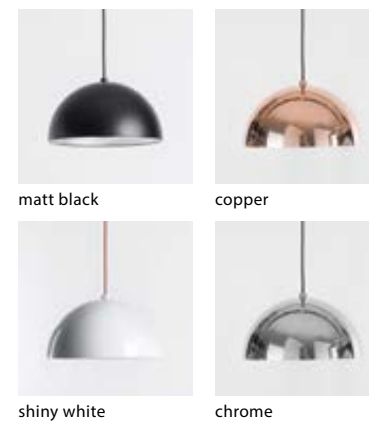

matt black

copper

shiny white

chrome

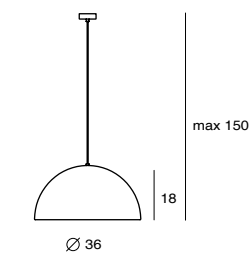

Dome Pendant M
SQ-360MP
E27 1 x Max 46W
Ribbed reflector
bulb cover

Materials: steel, aluminum
Color : copper w/ black textile wire
chrome w/ black textile wire
matt black w/ black textile wire
shiny white w/ red textile wire
Canopy : Type A, same as shade color
Back Plate : Type A

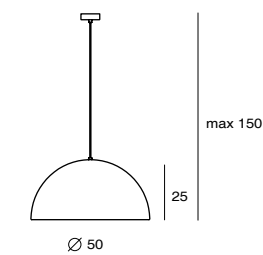

Dome Pendant L
SQ-3650MP
E27 1 x Max 46W
Ribbed reflector
bulb cover

Materials: steel, aluminum
Color : copper w/ black textile wire
chrome w/ black textile wire
matt black w/ black textile wire
shiny white w/ red textile wire
Canopy : Type A, same as shade color
Back Plate : Type A

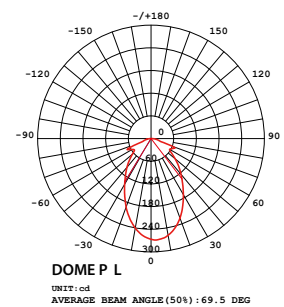

DOME P L
UNIT: cm
AVERAGE BEAM ANGLE (50%): 69.5 DEG



Dora Pendant P12



DORA 朵拉

By Chang, Ting Ting 張婷婷, 2015

Our DORA collection is Oh So Chic! Our up-and-coming young designer, Ting, drew the inspiration from her childhood. She wanted to create a collection that was versatile, interactive, and fun. With DORA, end users can really be a child again. Have fun with the collection and hang it individually or in a cluster, in whatever position your heart desires. Combined with cutting edge technology, the DORA is embedded in a CRI 90 LED luminance that gently distributes the light. We conveniently offer three suspension methods: pendant, chandelier, and circular suspension.

從點－線－面開始延伸無窮想像，使用者可依需求，任選符合空間需求的數量，將人與空間完整地串連，並且奔放想像，創造夜裡最斑斕夢幻的獨家星空。DORA 內嵌 CRI 90 的 LED 光源，有著如太陽般真實呈現色彩的特質；然減低光源熱度，在恣意創造的同時，兼顧能源意識，減輕環境負擔。DORA 更多新可能，一起來創造吧！



matt black copper
shiny brass chrome

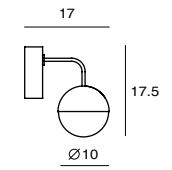

Dora Wall
SLD-1010WDTE
LED 1 x 6.5W (3000K, CRI 90, 550lm)
Shade rotatable
Built-in driver
Touch dimmer switch

Materials: steel, clear glass
Color: copper
shiny brass
chrome
matt black
Canopy : Type A53, same as shade color
Back Plate : Type B3

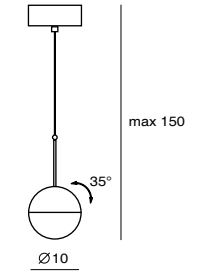

Dora Pendant P1
SLD-1010P
LED 1 x 6.5W (3000K, CRI 90, 550lm)
Shade rotatable
Built-in driver
Black PVC wire

Materials: steel, clear glass
Color: copper
shiny brass
chrome
matt black
Canopy : Type A24, matt black
Back Plate : Type A6



Dora Pendant PL5

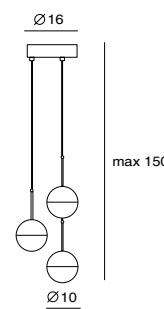

Dora Pendant P3
SLD-1010P3
LED 3 x 6.5W (3000K, CRI 90, 1650lm)
Shade rotatable
Built-in driver
Black PVC wire

Materials: steel, clear glass
Color: copper
shiny brass
chrome
matt black
Canopy : Type A13, matt black
Back Plate : Type A8

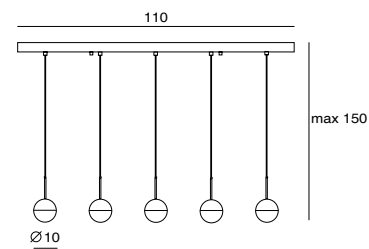

Dora Pendant PL5
SLD-1010PL5
LED 5 x 6.5W (3000K, CRI 90, 2750lm)
Shade rotatable
Built-in driver
Black PVC wire

Materials: steel, clear glass
Color: copper
shiny brass
chrome
matt black
Canopy : Type R1, matt black
Back Plate : Type R1

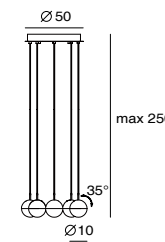

Dora Pendant P8
SLD-1010P8
LED 8 x 6.5W (3000K, CRI 90, 4400lm)
Shade rotatable
Built-in driver
Black PVC wire

Materials: steel, clear glass
Color: copper
shiny brass
chrome
matt black
Canopy : Type A26, matt black
Back Plate : Type A16

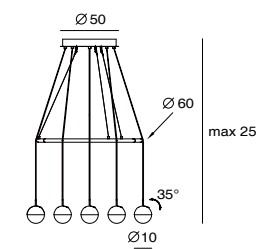

DORA Pendant PC8
SLD-1010PC8
LED 8 x 6.5W (3000K, CRI 90, 4400lm)
Shade rotatable
Built-in driver
Ring height adjustable
Black PVC wire

Materials: steel, clear glass
Color: copper
shiny brass
chrome
matt black
Canopy : Type A26, matt black
Back Plate : Type A16

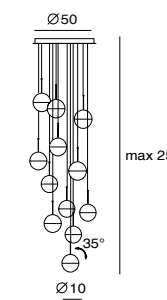

DORA Pendant P12
SLD-1010P12
LED 12 x 6.5W (3000K, CRI 90, 6600lm)
Shade rotatable
Built-in driver
Black PVC wire

Materials: steel, clear glass
Color: copper
shiny brass
chrome
matt black
Canopy : Type R2, matt black
Back Plate : Type R2

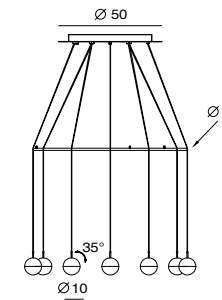

DORA Pendant PC12
SLD-1010PC12
LED 12 x 6.5W (3000K, CRI 90, 6600lm)
Shade rotatable
Built-in driver
Ring height adjustable
Black PVC wire

Materials: steel, clear glass
Color: copper
shiny brass
chrome
matt black
Canopy : Type R2, matt black
Back Plate : Type R2

Bespoke Large Multi-tiered Chandelier

GLACIER 冰河

By Chen, Chao Cheng 陳昭成, 2008



Composed of thick transparent glass and chrome-finished inner shade, the tiny lamp Glacier glows gently among spaces. As the glacier in ice age, the lamp GLACIER wakes people with its warm light.

厚實的透明玻璃，就像冰河時期時冷艷的冰川，光影層層反射出晶透耀眼的光芒。清透的加厚玻璃加上亮白烤漆金屬內反射罩，讓 GLACIER 閃耀著現代感十足的夠麗，簡潔流暢的外型雖小，卻依舊光彩奪目。

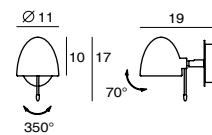

GLACIER W
SG-623WRE
G9 1 x Max 33W
Shade rotatable
Rotary dimmer

Materials : steel, clear glass
Color : chrome
Canopy : Type D, chrome
Back Plate : Type E1

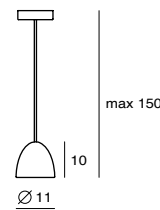

Glacier Pendant
SG-623P
G9 1 x Max 33W
Silver braided wire

Materials : steel, clear glass
Color : chrome
Canopy : Type A21, chrome
Back Plate : Type A

HELIO 日寰

By Chen, Chao Cheng 陳昭成, 2016



HELIO pendant gently keeps the illuminance flowing through its oval shade. Sleek cone-shaped pendant, HELIO, provides for a very modern yet straight forward aesthetic. A swirling brushed gold interior and a reflector bulb cover are added features to this pendant. The HELIO really is as alluring from the inside as it is from the outside.

傳說古希臘太陽神 Helios 俊美而高大，每天頭戴光芒四耀的金冠，給世界帶來光明。半橢圓的 Helio 外表中有個同心圓鋁反射罩，利用底部的燈泡蓋遮住刺眼的光線，兩者將直硬的光化為層次多變的柔和光氛，在寒冷的冬日下，身暖，心更暖！



matt black +
brushed apricot gold



matt white +
brushed rose gold

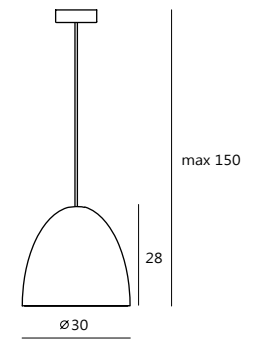

Helio Pendant
SQ-633MP
E27 1 x Max 46W
Ribbed reflector
bulb cover
Black textile wire

Material : steel
Color : matt white shade + brushed rose gold reflector
matt black shade + brushed apricot gold reflector
Canopy : Type A, chrome
Back Plate : Type A



HERCULES 海克力士

By Chen, Chao Cheng 陳昭成 & Li, Hui Lun 李慧倫, 2017

The HERCULES series was launched as tribute to the strong, courageous character of Greek mythology. Featuring brilliant mechanical structures while maintaining the essential spirit of design, the HERCULES provides a stunning balance between form and function. Users can turn on and dim the LED light via a swirling switch, adjust the rotating shade and create a perfectly placed arc with the simple move of a lever. The HERCULES is strong yet flexible enough to fit your specific lighting needs.

靈感取自希臘神話半人半神的大力士 - HERCULES。設計師將他驍勇善戰、擊退惡勢力帶來光明的精神，注入燈具靈魂。彈頭型燈罩象徵和平的守護，微彎身軀則隱喻矚目不忘謙虛的處事道理。為了貼近使用者生活體驗，整盞燈擁有多處調節的結構裝置。它像是自信得體的紳士，時而謙虛時而挺拔，投射出獨特優雅的光氛美學。

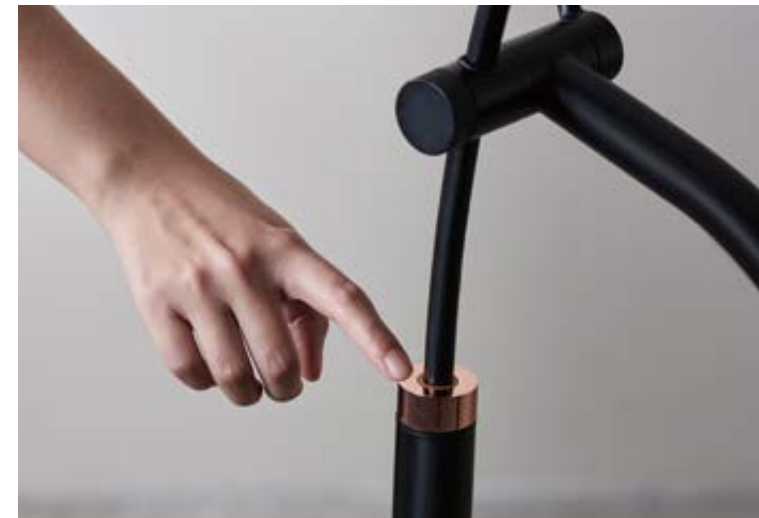

copper shade +
matt black body



matt brass shade +
matt black body

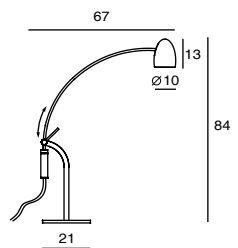

Hercules Table
SLD-79DTE
LED 8.6W (3000K, CRI 90, 730lm)
Shade rotatable
Arm adjustable
Touch dimmer switch
Black textile cord

Material : steel
Color : copper shade + matt black body
matt brass shade + matt black body

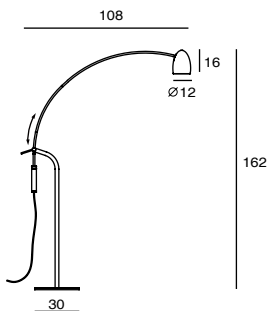

Hercules Floor
SLD-791FTE
LED 12W (3000K, CRI 90, 1020lm)
Shade rotatable
Arm adjustable
Touch dimmer switch
Black textile cord

Material : steel
Color : copper shade + matt black body
matt brass shade + matt black body



ICE 晶采

By Chen, Chao Cheng 陳昭成, 2005

Light up the northern light, feeling what are reflected into your eyes as putting yourself in the north. ICE is visibly composed of icecube-like glass shades, which seems to be melted by the warm light.

點亮北極光，感受冰雪反射所有可見的亮，彷彿置身於北方國度。溫暖的色溫與冰塊的外表相調和，體驗冬季風情的同時也溫暖您的心。



Ice Table
SD-62D1
G4 1 x Max 20W

Materials : clear glass + steel
Color : shiny satin

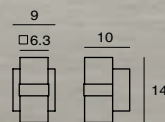

Ice Wall
SD-60W2
G4 2 x Max 20W

Materials : frosted glass + steel
Color : shiny satin
Canopy : Type B3, chrome
Back Plate : Type A4

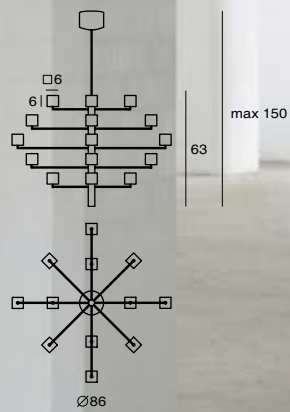

Ice Pendant P20
SD-62CFL20
G4 20 x Max 10W
Clear wire

Materials : clear glass + steel
Color : chrome
Canopy : Type A7, chrome
Back Plate : Type A3



KAZOKU 家族

By Chen, Chao Cheng 陳昭成, 2005

KAZOKU means "family" in Japanese. To gather with beloved people, sitting at the dining table is the most cherished moment. KAZOKU is composed of mouth-blown opal glasses, which soften the light gently. The fixture is rotatable and allows you to change it from the "-" to "+" on occasion.

享用美食與凝聚家人情感必備的晚餐，少不了一盞襯托色、香、味及溫馨氣氛的燈飾，讓所有的團圓格外舒適。由手工口吹玻璃組成的「家族」餐吊燈，可由「一字型」轉成「十字型」，為您用餐時、工作時、閱讀時找到最合適的角度。有沒有發現，燈罩、燈體和壁蓋的剖面，都是特殊形狀呢？

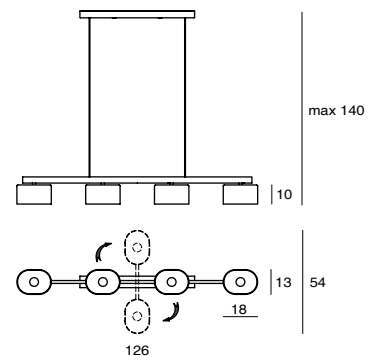

Kazoku Pendant
SG-323CTR4
G9 4 x Max 33W
Rotatable cross bar
Black textile wire

Materials : mouth-blown glass, steel
Color : matt opal + matt black

Canopy : Type C5, chrome
Back Plate : Type A9



JOJO LED 悠悠

By Chen, Chao Cheng 陳昭成, 2017

With an adjustable height shade inspired by the movement of a Yo-Yo, the JOJO pendant is a traditional shape with modern sensibilities. Lit with an LED bulb, the JOJO casts a gentle, calm illumination through the hand-blown opal shade.

隨著溜溜球一上一下，心情彷彿也在這反覆之中獲得宣洩。JOJO 的平衡裝置，可以讓你隨時調整燈罩高度，伴著口吹玻璃滲透出溫暖光暈，像音符般譜出每日的心情樂章。新版 LED 吊燈還原設計師於 1994 年設計初表，上下兩抹圓潤象徵圓滿喜樂；藉由光氛，我們傳達對居家的真摯祝福。



matt opal + copper cap



matt opal + matt brass cap

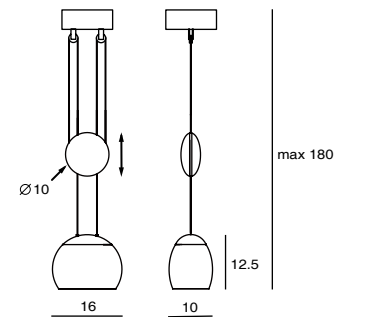

Jojo LED Pendant

SLD-880
LED 8.2W (2700K, CRI 90, 675lm)
Length adjustable
Built-in driver
Oval lens
Silver braided wire

Materials : mouth-blown glass, steel
Color : matt opal + copper cap
 matt opal + matt brass cap
Canopy : Type A28, matt white canopy
Back Plate : Type A

LAITO 光

By Chen, Chao Cheng 陳昭成, 2017



LAITO collection is a tribute to vintage designs. The idea came from "banking lamps" which were largely used in banks back in old days. It has a specialized fishbone-like structure to enhance balance and allow the lampshade to rotate. When you focus on works, LAITO is focusing on you.

Laityo 是日文的「光明」之意，外型汲取自經典不朽的燈罩以及傳統銀行燈的「魚骨結構」，是對復古的眷戀；以俐落的線條、霧面烤漆重新定義出都市低調與簡單的性格，搭配可 350° 轉動的新魚骨結構，讓「光」帶著復古，走入現代實用簡約生活之中。

Laito Pendant L

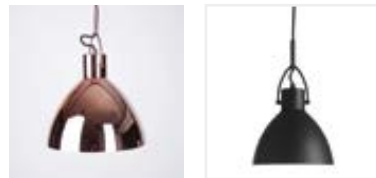

copper

matt black

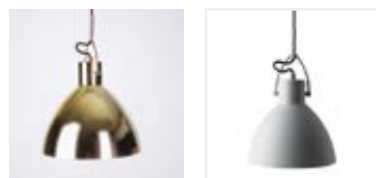

matt brass

matt white



chrome

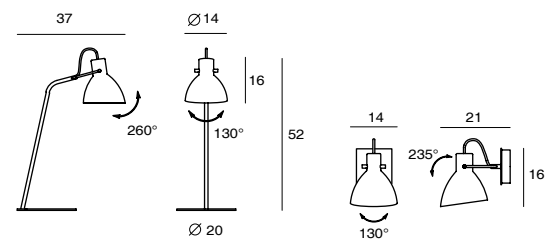

Laito Table

SQ-893MDB
E27 1 x Max 46W
Shade rotatable
Black textile cord

Material : steel
Color : matt black
matt white

Laito Wall

SQ-893MWR
E27 1 x Max 46W
Shade rotatable
On/off rotary switch
Black textile wire

Material : steel
Color : matt black
matt white
Canopy : Type B8, same as shade color
Back Plate : Type A5

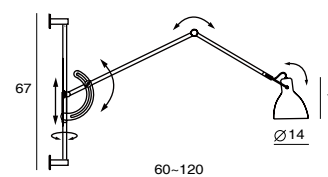

Laito Wall Mega

SQ-894MWL
E27 1 x Max 46W
Shade & arm rotatable
In-line on/off switch
Black textile wire

Material : steel
Color : matt black + copper
matt black + matt brass
matt black + chrome
Canopy : Type B11

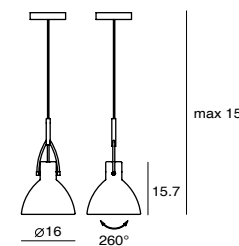

Laito Pendant S

SQ-895MP
E27 1 x Max 46W
Shade rotatable
Black textile wire

Material : steel
Color : copper
matt brass
chrome
matt black
matt white
Canopy : Type A, same as shade color
Back Plate : Type A

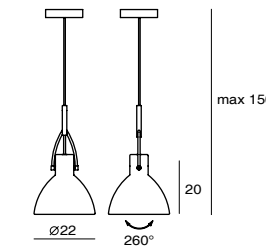

Laito Pendant M

SQ-8961MP
E27 1 x Max 46W
Shade rotatable
Black textile wire

Material : steel
Color : copper
matt brass
chrome
matt black
matt white
Canopy : Type A, same as shade color
Back Plate : Type A

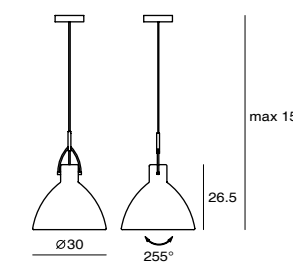

Laito Pendant L

SQ-897MP
E27 1 x Max 46W
Shade rotatable
Black textile wire

Material : steel
Color : copper
matt brass
chrome
matt black
matt white
Canopy : Type A, same as shade color
Back Plate : Type A

LAITO MINI 微光

By Chen, Chao Cheng 陳昭成, 2013

The smallest LAITO in the series, the mini wall lamp has inherited the classic streamlined look and flexible functionality of its larger counterparts.

It offers two types to choose. The mini WL version is with an adjustable arm and shade the wall mounted lamp can be perfectly positioned for your task at hand. As with the rest of the LAITO series aesthetic is never compromised by function.

Laito 是日文的「光明」之意。LAITO MINI 外型汲取傳統銀行燈的燈罩造型與結構，歌頌復古典雅，並以俐落的線條，刻畫出更符合都市低調樂活的性格，搭配可任意轉動的魚骨結構，「光」，循著現代復古美學，走入精巧簡約生活中。此系列完整地包含桌、壁、吊燈。

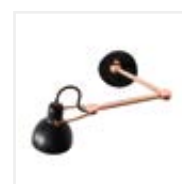

matt black + copper

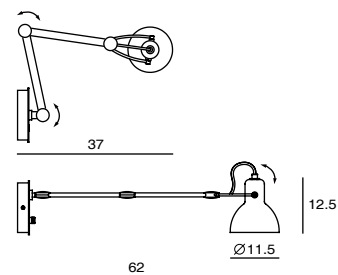

Laito Mini Wall L

SQ-793MWA
E14 1 x Max 25W
Shade & arm rotatable
On/off rotary switch
Black textile wire

Material : steel
Color : matt black shade + copper arm
Canopy : Type A14, matt black
Back Plate : Type B4



copper



matt black



matt brass



matt white



chrome

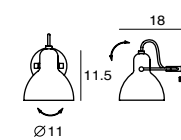

Laito Mini Wall

SQ-793MWR
E14 1 x Max 25W
Shade rotatable
On/off rotary switch
Black textile wire

Material : steel
Color : copper
matt brass
chrome
matt black
matt white
Canopy : Type A30, same as shade color
Back Plate : Type A6

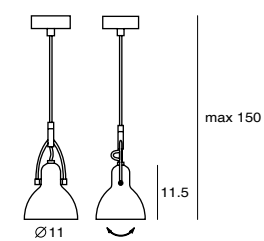

Laito Mini Pendant

SQ-793MP
E14 1 x Max 25W
Shade rotatable
Black textile wire

Material : steel
Color : copper
matt brass
chrome
matt black
matt white
Canopy : Type A12, same as shade color
Back Plate : Type A18

LAITO GENTLE 紳光

By Chen, Chao Cheng 陳昭成 & Wan, Jack 萬華, 2017



The LAITO Gentle is inspired by modern gentlemen who is in particular reckoned as properly-dressed, caring for details along with exquisite taste. This is a design of which takes full advantage of the mechanical intelligence and vintage aesthetics. Spinning the rotary switch allows to find the suitable height, together with the lampshade provides a multi-direction adjustment function. It is elegantly matched with refined hues to perform as the best mate every man should keep.



navy blue + copper

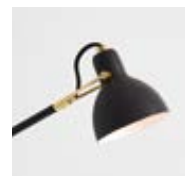

duke gray + matt brass

家族成員豐富的 LAITO 系列，各自散發不同性格風範。LAITO Gentle 紳光是家族中品味獨特、注重日常穿搭與生活態度的紳士代表。自衣領、袖扣、錶件到襪子鞋履，無一不是精準細膩的拿捏展現。我們將這份態度融入燈體靈魂，時髦復古的烤漆刷色，透過金屬配件強化風格及吸睛效果，為熱愛生活、獨具美學觀點的現代男仕，打造一盞居家絕佳夥伴。

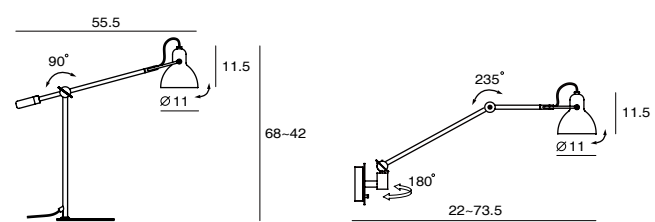

Laito Gentle Table

SQ-793MDR
E14 1 x Max 25W
Shade & arm rotatable
In-line on/off switch
Black textile wire

Material : steel
Color : navy blue + copper
duke gray + matt brass

Laito Gentle Wall

SQ-793MWRL
E14 1 x Max 25W
Shade rotatable
On/off rotary switch
Black textile wire

Material : steel
Color : navy blue + copper
duke gray + matt brass
Canopy : Type A30, same as shade color
Back Plate : Type B3



LAITO OPAL 玻光

By Chen, Chao Cheng 陳昭成, 2017



In keeping with the LAITO series vintage heritage the LAITO Opal adds softness to the classic, streamlined shape, evoking a subdued glow of years gone by. It can be perfectly positioned for your task at hand. As with the rest of the LAITO series aesthetic is never compromised by function.

手工玻璃擁抱機器仿效不出的樸實風貌，這一顆顆捧在手心上的輕透溫潤，承載工匠自學徒到老師傅所逝去的年華份量。我們想將這珍貴雋永的人文工藝，透過反射與折射，呈現出夜色下水光激瀾、引人佇足之美。為您帶來「玻光」系列。

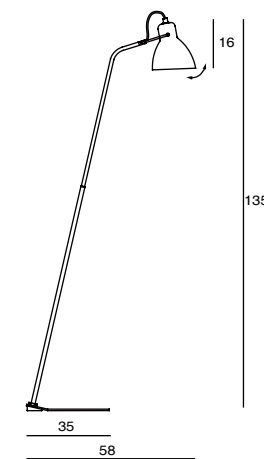

Laito Opal Floor
 SQ-893FB
 E27 1 x Max 46W
 Shade rotatable
 On/off foot switch
 Black textile cord

Materials : mouth-blown glass, steel
 Color : matt opal shade + matt brass body + matt white base

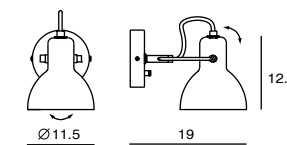

Laito Opal Wall
 SQ-793WR
 E14 1 x Max 25W
 Shade rotatable
 On/off rotary switch
 Black textile wire

Materials : mouth-blown glass, steel
 Color : matt opal shade + matt brass body
 Canopy : Type A43, matt white
 Back Plate : Type B3

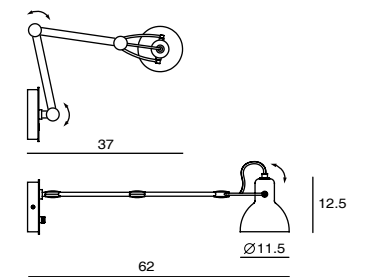

Laito Opal Wall L
 SQ-793WA
 E14 1 x Max 25W
 Shade & arm rotatable
 On/off rotary switch
 Black textile wire

Materials : mouth-blown glass, steel
 Color : matt opal shade + matt brass body
 Canopy : Type A14, matt white
 Back Plate : Type B4



RE LALU 光華島

By Chen, Chao Cheng 陳昭成, 2017

"Lalu" is a holy island in the legend of one of Taiwanese aborigines--Thao. It has been symbolized to be the residence of ancestors' spirits. The Re-Lalu is natural wood based with mouth-blown glass. The combination plays a harmony between the nature and humanity art.

日月潭中的光華島，是邵族人最高祖靈 paclan 的居處，邵語稱為 lalu。2018 年推出新版 LALU，運用涵藏生命肌理的木頭與手工口吹玻璃，配上經典黑白色系，尋回那與自然共生共利的人文足跡。



shiny opal +
matt black



shiny red +
matt black

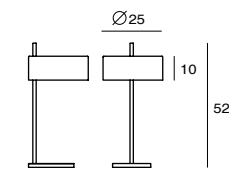

Re Lalu Table
SQ-250DW
E27 1 x Max 46W
Push on/off switch
Black textile cord

Materials : mouth-blown glass, oak, steel
Color : shiny opal + matt black
shiny red + matt black

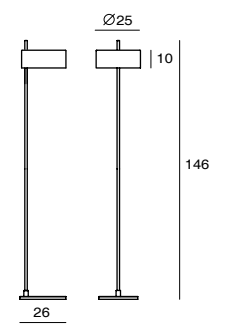

Re Lalu Floor
SQ-250FW
E27 1 x Max 46W
Push on/off switch
Black textile cord

Materials : mouth-blown glass, oak, steel
Color : shiny opal + matt black
shiny red + matt black



LALU+ 拉魯

By Chen, Chao Cheng 陳昭成, 2014

The LALU collection has been beloved and highly regarded for many years. Nonetheless, at SEED we are always thinking the unthinkable, thus we've reinterpreted this charming collection with a contemporary twist. Keeping up with the trends in home furnishing and accessories, we too have to get creative and ensure our pieces are multi-functional. The linear fixture of LALU+ pendant can be now be rotated to create cross or straight formations.

座落于日月潭上的小島，是邵族祖先鞠躬耕耘、孕育血脈至最終安息的聖土。LALU 取此寓言，將鬱鬱山林與翠澈水景交融的影像，化做夜色蒼茫中的一絲靜謐。隨著環境意識抬頭，新一代 LALU+ 重新演繹經典，以金屬取代玻璃。外型更具張力，功能亦有革新，使用者可依需求，由「一」至「十」轉動燈桿角度，彷彿翻轉農光氛於居家之中。





copper +
matt black



shiny jolly green +
matt brass

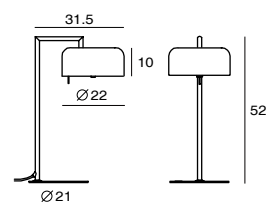

Lalu+ Table
SQ-250MDR
E27 1 x Max 46W
Dip switch
Shade rotatable
Black textile cord

Materials : steel, acrylic diffuser
Color : copper + matt black
shiny jolly green + matt brass

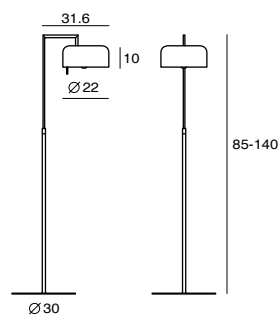

Lalu+ Floor
SQ-250MFR
E27 1 x Max 46W
Dip switch
Shade rotatable
Height adjustable
Black textile cord

Materials : steel, acrylic diffuser
Color : copper + matt black
shiny jolly green + matt brass

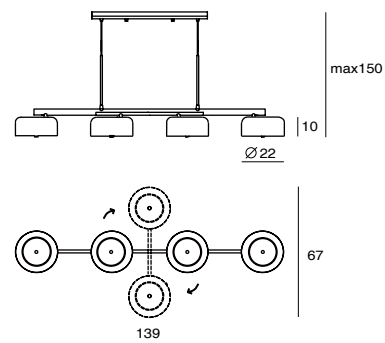

Lalu+ Pendant PL4
SQ-250MCTR4
E27 4 x Max 46W
Rotatable cross bar
Black textile wire

Materials : steel, glass diffuser
Color : copper + matt black
Canopy : Type C5, matt black
Back Plate : Type A1

LALU+ LED 拉魯 LED

By Chen, Chao Cheng 陳昭成 2017



The LALU+ collection has been beloved and highly welcomed since its launch. The brilliant feature of rotated linear fixture enhances the interaction with users. Keeping up the identity, we reinterpreted this fascinating item into the LALU+ LED.

There are two formations of suspensions, the chandelier enables us to rotate each fixture, creating multiple expressions through layers; while the linear pendant makes charming match on table and kitchen island. The whole collection offers suspensions and wall lamps.

LALU+ 拉魯除了有戲劇張力的外型，智慧燈桿結構「一」轉「十」的特點，重新翻轉人們與餐桌的美味關係。延伸系列 LALU+ LED 保留底部柔光片設計，將光源進階成高演色性 LED 模組。全系列有吊、壁燈兩種品項，其中，吊燈除了適合吧台與餐桌的長型款，亦添加樹枝狀主燈，多層枝節任意轉動的特點，讓使用者在不同情境中，隨時更換最合意的光氛表情。



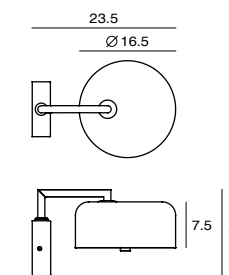
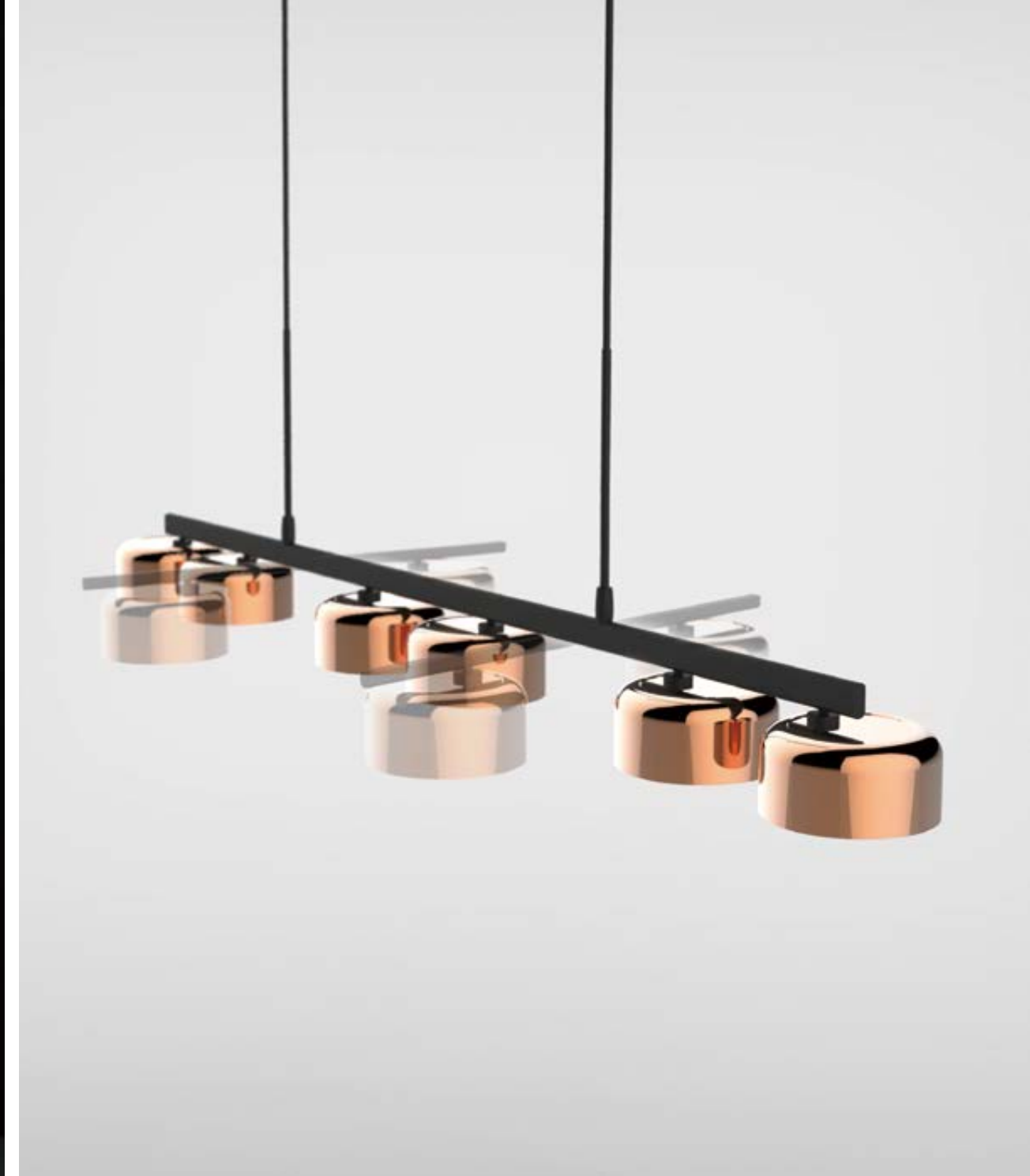

Lalu+ Wall
 SLD-2501MWRTE
 LED 5W (2700K CRI 90, 425lm)
 Shade rotatable
 Touch dimmer switch

Materials : steel, PS diffuser
 Color : copper + matt black
 Canopy : Type B9, matt black
 Back Plate : Type A20

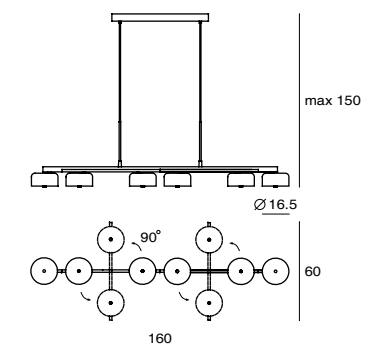

Lalu+ Pendant PL6
 SLD-2501MCTR6
 LED 6 x 5W (2700K CRI 90, 2700lm)
 Rotatable cross bar
 Black textile wire

Materials : steel, PS diffuser
 Color : copper + matt black
 Canopy : Type C8, matt black
 Back Plate : Type A1

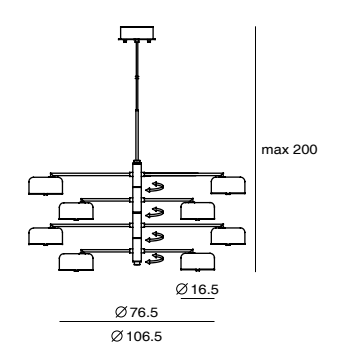

Lalu+ Pendant P8
 SLD-2501MPR8
 LED 8 x 5W (2700K CRI 90, 3600lm)
 Rotatable cross bar
 Black textile wire

Materials : steel, PS diffuser
 Color : copper + matt black
 Canopy : Type A32, matt black
 Back Plate : Type A19



LING 欄

By Li, Hui Lun 李慧倫, 2017

LING is a harmonious mingle of minimalism and nostalgia design which is inspired by patterned metal-fence used to be built around balconies and windows in early Taiwan. The copper/ brass glow elegantly connects glass and metal shade. Through inner reflection of embedded LED light source, the adorable lamp impressively creates double ambience in one single fitting.

台灣老宅邸的生命敘事，圈圍在金屬條勾勒的鐵窗花之中，那多變獨特的圖騰，除了功能考量，亦沿襲家族根源的光景。

LING 欄宛如一名搭乘時光列車的詩人，遊走於懷舊與現代，寫下美學間相遇的悸動與火花。取材自鐵窗花的金屬框，恰到好處的留白，一點一滴收藏空間的溫度與記憶；異材質燈罩的融合，流露典雅氣息，使用上不僅通透、創造雙重光氛質感，也能局部轉動，為日常蔓延趣味新意。



matt black +
copper ring



matt white +
matt brass ring

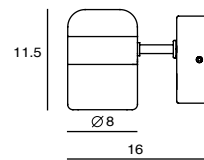

Ling Wall

SLD-80WTE
LED 6W (3000K, CRI 90, 520lm)
Touch dimmer switch
Shade rotatable

Materials : frosted glass, steel
Color : matt black + copper ring
 matt white + matt brass ring
Canopy : Type A54, same as shade color
Back Plate : Type B3





Ling Pendant Horizontal / Ling Pendant Vertical

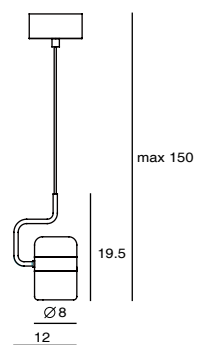

Ling Pendant S
 SLD-80PS
 LED 6W (3000K, CRI 90, 520lm)
 Built-in dimmable driver
 Black PVC wire

Materials : frosted glass, steel
 Color : matt black + copper ring
 matt white + matt brass ring
 Canopy : Type A39, same as shade color
 Back Plate : Type A6

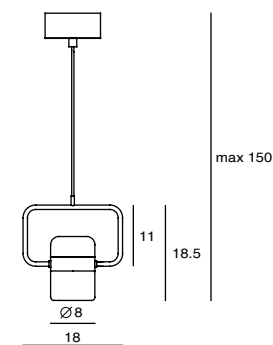

Ling Pendant Horizontal
 SLD-80PH
 LED 6W (3000K, CRI 90, 520lm)
 Built-in dimmable driver
 Shade rotatable
 Black PVC wire

Materials : frosted glass, steel
 Color : matt black + copper ring
 matt white + matt brass ring
 Canopy : Type A39, same as shade color
 Back Plate : Type A6

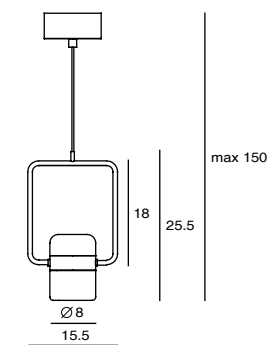

Ling Pendant Vertical
 SLD-80PV
 LED 6W (3000K, CRI 90, 520lm)
 Built-in dimmable driver
 Shade rotatable
 Black PVC wire

Materials : frosted glass, steel
 Color : matt black + copper ring
 matt white + matt brass ring
 Canopy : Type A39, same as shade color
 Back Plate : Type A6

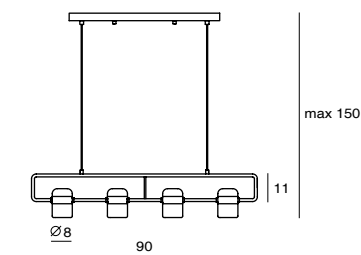

Ling Pendant PL4
 SLD-80PF4
 LED 4 x 6W (3000K, CRI 90, 2080lm)
 Built-in dimmable driver
 Shade rotatable
 Black PVC wire

Materials : frosted glass, steel
 Color : matt black + copper ring
 matt white + matt brass ring
 Canopy : Type C11, same as shade color
 Back Plate : Type A25

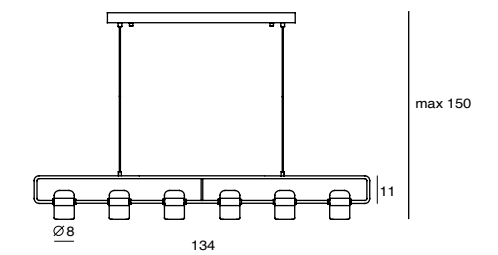

Ling Pendant PL6
 SLD-80PF6
 LED 6 x 6W (3000K, CRI 90, 3120lm)
 Built-in dimmable driver
 Shade rotatable
 Black PVC wire

Materials : frosted glass, steel
 Color : matt black + copper ring
 matt white + matt brass ring
 Canopy : Type C10, same as shade color
 Back Plate : Type A24



Mist Pendant M

MIST 嵐

By Chen, Chao Cheng 陳昭成, 2014

Centuries ago, many Chinese poets composed beautiful poems inspired by intriguing mountainous sceneries. When standing on a mountaintop, people seem to be close enough to be able to touch the clouds with their fingertips and feel the mists against their faces. In dedication to those inspiring poems, we've created MIST in hopes to capture that very moment. MIST combines precision craftsmanship with laborious technique, sand-blasting every piece by hand. Turn the light on and MIST will calmly illuminate your surroundings.

山林層巒疊翠，雲霧翻湧而變化於虛無縹緲間的曩繞景象，若能捕捉住，時而欣賞，多麼令人快意！點綴空間盎然樣的 MIST 吊燈，經由老師傅多年經驗操刀，精彩地將大片風景與玻璃交融。似有若無的霧面噴砂處理，自底部雲湧而起，燈亮時的氤氳感，彷彿日出初醒的光絲，瀰漫於雲海間；熄燈時的 MIST，恰如朵朵白雲，輕躍天空。



copper



matt brass

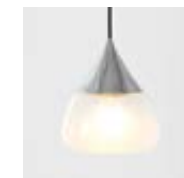

chrome

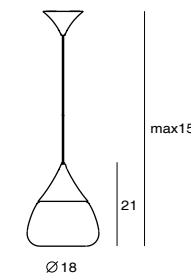

Mist Pendant M
SQ-8997P
E27 R63 1 x Max 50W
Black textile wire

Materials : mouth-blown glass, steel
Color : sand-blasted glass + copper
sand-blasted glass + matt brass
sand-blasted glass + chrome
Canopy : Type D2, same as shade color
Back Plate : Type A12

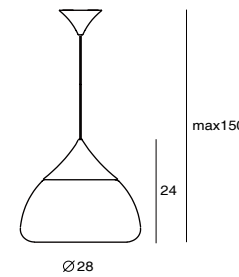

Mist Pendant L
SQ-8997PL
E27 R80 1 x Max 50W
Black textile wire

Materials : mouth-blown glass, steel
Color : sand-blasted glass + copper
sand-blasted glass + matt brass
sand-blasted glass + chrome
Canopy : Type D2, same as shade color
Back Plate : Type A12



MOAI 摩艾

By Chen, Chao Cheng 陳昭成, 2017

When illuminated the MOAI provides an atmospheric, ambient glow as light moves through the sphere and bounces off the clear glass shade creating a unique egg-shaped reflection. A beautiful silhouette reminiscent of the stone statues of Easter Island, the MOAI is dynamic whether on or off.

這是一盞「會呼吸的燈」，在吐納間散放細緻光氛。
MOAI 靈感取自復活節島上的摩艾石像，設計師描其輪廓，結合清玻璃透視效果與金屬亮面質感，為現代人繁忙的生活步伐捎來一絲徐緩氣息。簡約剔透的外型能自在穿梭於現代留白的寧靜場域及瀟灑復古風味的人文空間；微小光束顆粒在玻璃內部來回漫射碰撞，隨著不同視角轉化成厚薄不一的精巧光蛋，增添空間趣味。





Moai Pendant L



Moai Pendant S



shiny copper



shiny brass

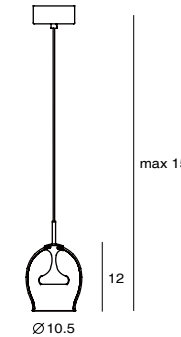

Moai Pendant S

SLD-105P
LED 6.5W (3000K, CRI 90, 553lm)
Black PVC wire
Built-in dimmable driver

Materials : steel, clear glass
Color : shiny copper
shiny brass
Canopy : Type A39, matt black
Back Plate : Type A6

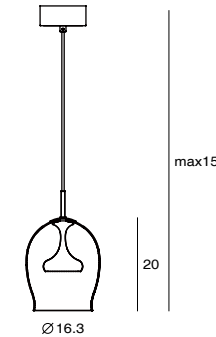

Moai Pendant M

SLD-201P
LED 8.5W (3000K, CRI 90, 720lm)
Black textile wire
Built-in dimmable driver

Materials : steel, clear glass
Color : shiny copper
shiny brass
Canopy : Type A16, matt black
Back Plate : Type A

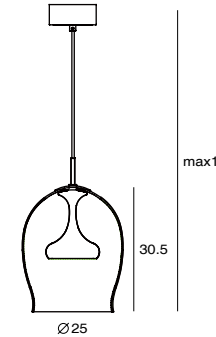

Moai Pendant L

SLD-304P
LED 13W (3000K, CRI 90, 1105lm)
Black textile wire
Built-in dimmable driver

Materials : steel, clear glass
Color : shiny copper
shiny brass
Canopy : Type A16, matt black
Back Plate : Type A

MUMU 目木

By Kuo, Keng Dian 郭庚典, 2015



Designer Dian has been mastering the artistry of woodworking for years. He's always had an appreciation towards the organic nature the material exhibits. In the MUMU pendant, he utilizes the coolness of metal married with an LED light source, and counter-balances this with the warmth of the wood on both ends of the pendant. The MUMU is available in two versions: Matt White with Beech and Matt Black with Walnut.

目木由年輕設計師所設計，研習木工多年的他，精心結合前端科技與木頭特性，將高演色性的LED光源(CRI >90)嵌入流線俐落的金屬燈體，而自然的木紋則相合在燈體兩側，混搭出溫和而沈靜的舒心感受。疲累時望見「目木」，彷彿身在蕙鬱林木中，吐納那片療癒人心的自然美景。

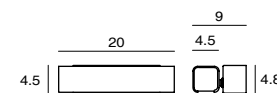

Mumu Wall

SLD-3981W
LED 5.7W (3000K, CRI 90, 400lm)
Shade rotatable
Built-in dimmable driver

Materials : aluminum, wood
Color : matt black + walnut (wood cap)
 matt white + beech (wood cap)
Canopy : Type B10, same as shade color
Back Plate : Type E2

Mumu Wall Dim

SLD-3981WPE
LED 5.7W (3000K, CRI 90, 400lm)
Shade rotatable
Push dimmer switch

Materials : aluminum, wood
Color : matt black + walnut (wood cap)
 matt white + beech (wood cap)
Canopy : Type B10, same as shade color
Back Plate : Type E2



Mumu Pendant 120





Mumu Pendant 120



matt black



matt white

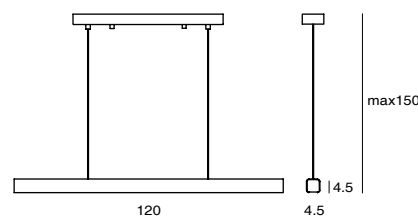

Mumu Pendant 120

SLD-3981P
LED 32W (3000K, CRI 90, 2150lm)
Built-in dimmable driver
Black PVC wire

Materials : aluminum, wood
Color : matt black + walnut (wood cap)
matt white + beech (wood cap)
Canopy : Type M, same as shade color
Back Plate : Type A1

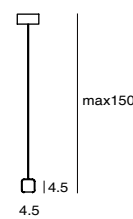

Mumu Pendant 120 Dim

SLD-3981PPE
LED 32W (3000K, CRI 90, 2150lm)
Push dimmer switch
Black PVC wire

Materials : aluminum, wood
Color : matt black + walnut (wood cap)
matt white + beech (wood cap)
Canopy : Type C9, same as shade color
Back Plate : Type A21

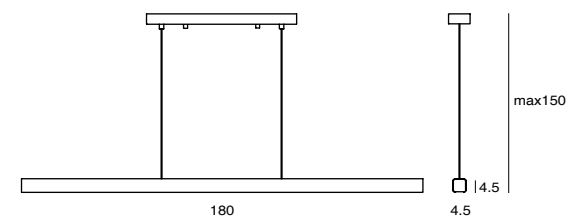
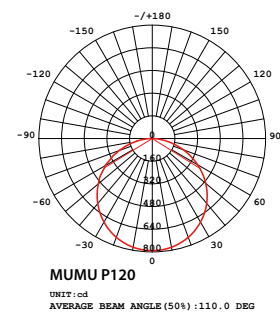

Mumu Pendant 180

SLD-3981PL
LED 48W (3000K, CRI 90, 3800lm)
Built-in dimmable driver
Black PVC wire

Materials : aluminum, wood
Color : matt black + walnut (wood cap)
matt white + beech (wood cap)
Canopy : Type C10, same as shade color
Back Plate : Type A24

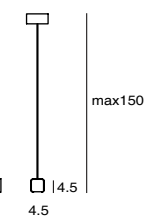

Mumu Pendant 180 Dim

SLD-3981PPE
LED 48W (3000K, CRI 90, 3800lm)
Push dimmer switch
Black PVC wire

Materials : aluminum, wood
Color : matt black + walnut (wood cap)
matt white + beech (wood cap)
Canopy : Type C12, same as shade color
Back Plate : Type A27

NEWTON 蘋果

By Chen, Chao Cheng 陳昭成, 2006



Before the apple knocked Newton, no one ever found the gravitation; people say "an apple a day keeps the doctor away". Apple is not only a kind of fruit but constructs the modern technological life by bumping into science. NEWTON is made of mouth-blown glass. It appears gently charming when you turn on the light.

蘋果敲醒牛頓以前，萬有引力從未被發現，現代的生活是來自於它與科學間美麗的邂逅。手工口吹玻璃製成的 NEWTON，就像顆豐碩的蘋果，圓潤自然的線條透出溫暖柔和的光暈，點綴空間，誘發童話般的甜蜜氛圍。

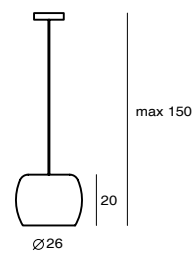

NEWTON P
SQ-7997P
E27 1 x Max 46W
Black textile wire

Material : mouth-blown glass, steel
Color : shiny opal
 shiny red
Canopy : Type A, chrome
Back Plate : Type A

NUMEN 精靈

By Li, Hui Lun 李慧倫, 2008



NUMEN lights differently each time when you give it a new look and shape. With NUMEN, you can let your inner creativity loose and bend the NUMEN to whatever your heart desires. Challenge your wildest imagination! NUMEN is constructed with silicone rubber, which is a safe material that offers countless advantageous properties such as thermal stability, low chemical reaction, and low toxicity. Staying lit for a full 20 minutes after its light source has been turned off, the fluorescent NUMEN literally falls asleep with you.

隨心所欲地塑捏它、點亮它就是一種樂趣。NUMEN 精靈桌燈以安全矽膠製成，不同於一般塑料，矽膠耐極端溫度 (-100~250°C)、抗腐蝕、無毒等安全特性，可以放心讓小孩玩耍揉捏，童心未泯！夜光型的精靈桌燈在熄滅後仍有 20 分鐘的微光，夜光的光線隨著人們入睡也逐漸變弱，同時達到舒眠與節能的效果，可當小夜燈使用。千變萬化的表情，亮出最甜蜜的光氛，怎麼能不征服您的心！

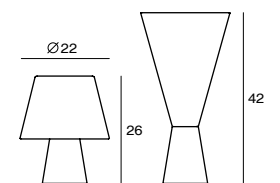

NUMEN D
SQ-420D
E27 1 x Max 46W
In-line on/off switch
Clear PVC cord
Flexible lampshade

Material : silicone rubber
Color : fluorescent green
 fluorescent lavender
 purple
 orange
 blue
 white



PENSÉE 思想

By Chen, Chao Cheng 陳昭成, 2005

Like the First quarter of the moon, PENSÉE lights through the mouth-blown opal glass. You can change the brightness by the patent DJ dimmer.

如同浮在雲端的上弦月，PENSÉE 透過手工口吹玻璃，灑下月光似的芒輝，透過專利的 DJ 調光器，帶你進入亦明亦暗的異想世界。

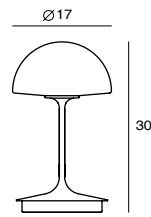

Pensée Table
SG-7992DJ
G9 1 x Max 33W
DJ on/off switch
Clear PVC cord

Materials : mouth-blown glass, steel
Color : matt opal + shinny satin



SNOWFLAKE 雪花

By Chen, Chao Cheng 陳昭成, 2007

Flying with winter breeze, romance of snowflakes softens the harsh season in the frigid zone. SNOWFLAKE is created to be a warmer in the coldness, as a gift in Xmas. Use chromed reflector bulb, the mouth-blown transparent glass gently ripples the light and shadow.

來自冬季紛飛的雪花片，經過手工口吹玻璃刻畫後更顯剔透。光透過折射後，在壁面上印出一圈圓瀾般的光影，如同沉浸在雪花紛飛下的聖誕季中，歡笑不絕於耳。輔以特殊鍍鎳燈泡使用，除了遮蔽眩光，也讓燈光反射回天花板形成無數光圈，七個玻璃反射的光圈無線交疊，無邊際的光圈倒影讓整個空間拉出層次，蔚然成景。



Snowflake Wall
SQ-2757WF
E27 1 x Max 46W

Materials : mouth-blown glass, steel
Color : clear glass + chrome
Canopy : Type A, chrome
Back Plate : Type A

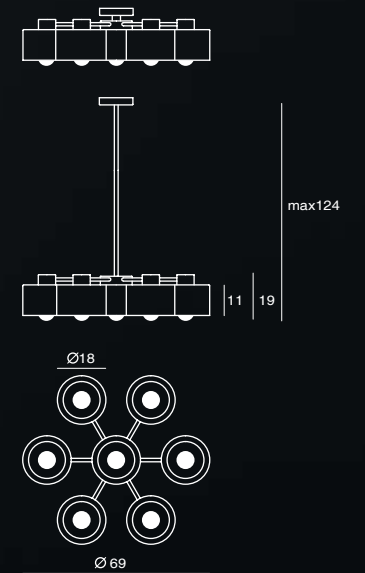

Snowflake Pendant P7
SQ-2757P7
E27 7 x Max 46W
Black textile wire

Materials : mouth-blown glass, steel
Color : clear glass + chrome
Canopy : Type A, chrome
Back Plate : Type A



PLANET 行星

By Chen, Chao Cheng 陳昭成, 2014

PLANET embodies and represents the SEED ideology. At SEED we are simple, elegant, practical, yet interactive. It took our design geniuses tiresome years to overcome a myriad of technical challenges, but finally, the PLANET has been born. Planet is incredibly polished and sophisticated, yet still so straightforward. The multi-adjustable parts provide the user the flexibility to meet their every need. Combining intelligent design with innovational aesthetics, the PLANET is ready to tenderly emit a moon-like illumination through genuine copper/ brass gear.

機械感強烈的 PLANET 行星系列，是匯集 SEEDDESIGN 於燈具結構上多年的智慧結晶。兼具美感及實用功能的行星，燈體上有許多部位，皆可依照使用者個人需求進行調整，如同私人秘書般提供完整的「專屬感」。壁燈款搭配的 180 度左右轉動固定架，擴大空間使用範圍，更加呼應現代室內配置上彈性利用空間的概念。



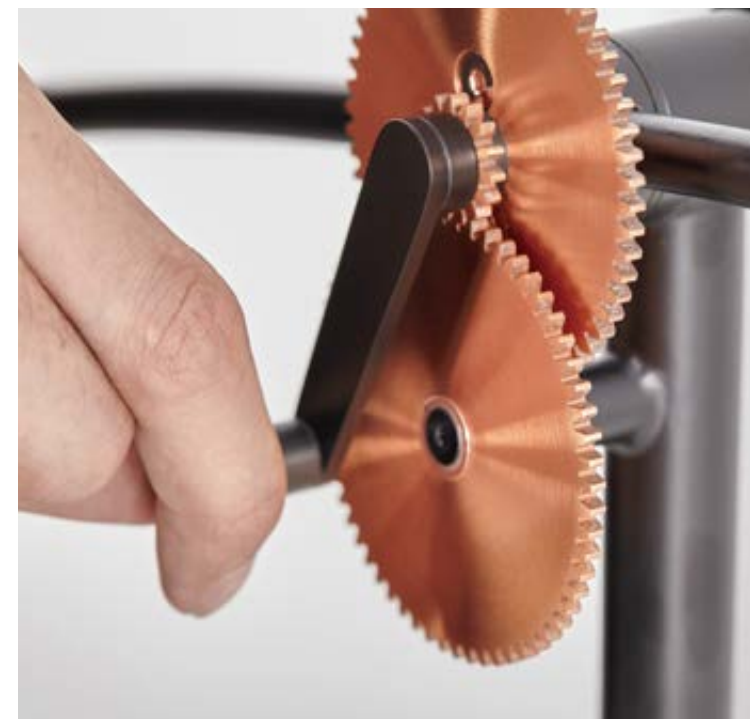

matt black + copper



matt black + matt brass

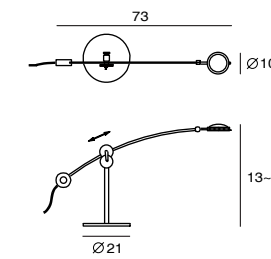

Planet Table
SLD-100DRTE
LED 8.6W (3000K, CRI 90, 600lm)
Multi- Direction adjustable
Touch dimmer swtich, adaptor driver
Black textile cord

Materials : steel, copper (gear), brass (gear)
Color : matt black + copper
matt black + matt brass

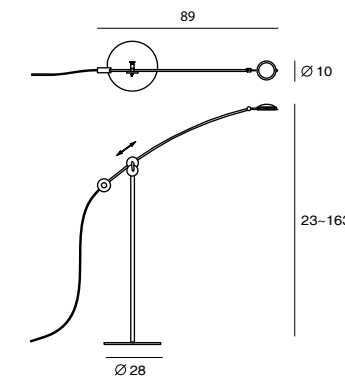

Planet Floor
SLD-100FRTE
LED 8.6W (3000K, CRI 90, 600lm)
Multi- Direction adjustable
Touch dimmer swtich, adaptor driver
Black textile cord

Materials : steel, copper (gear), brass (gear)
Color : matt black + copper
matt black + matt brass

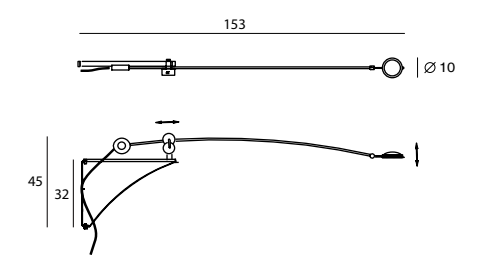

Planet Wall
SLD-100WRTE
LED 8.6W (3000K, CRI 90, 600lm)
Multi- Direction adjustable
Touch dimmer swtich, adaptor driver
Black textile cord

Materials : steel, copper (gear), brass (gear)
Color : matt black + copper
matt black + matt brass
Canopy : Type A33, matt black
Back Plate : Type A14



Qin is a status of being mentally refreshing. The steady texture of wood and the bright feeling of glass offer comfortable and balanced visual enjoyment. The integration of wood and glass materials causes a pleasantly surprising effect.

「沁」是滲入且浸潤心脾，以木頭、口吹玻璃與金屬結合出意想不到的效果。實木的穩重與玻璃的清透平衡出舒服感受，彷彿和煦的午後陽光從窗外輕輕灑入，清新感沁入人心。系列包括玻璃吊燈兩款，及金屬吊、壁燈各一款共四種型式。玻璃吊燈可使用鎢絲或節能燈泡；金屬系列使用 LED。壁燈搭配觸碰調光鍵並可 90 度左右擺動，找到最適合的亮度和角度。

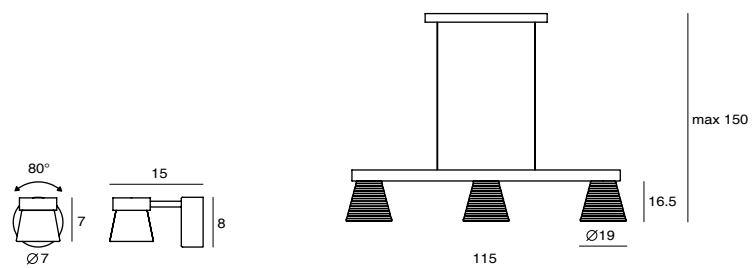

QIN W LED
SLD-92MWTE
LED 5W (3000K, CRI80, 425lm)
Shade rotatable
Touch dimmer switch

Materials : aluminum, wood
Color : matt black + beech (wood cap)
Canopy : Type A34, matt black
Back Plate : Type E

QIN P3
SQ-192CT3
E27 3 x Max 46W
Black textile wire

Materials : mouth-blown glass, wood
Color : shiny opal shade + beech (wood bar)
Canopy : Type C6, chrome
Back Plate : Type A1





Salute Pendant Cake / Salute Pendant Bell R / Salute Pendant Wine

SALUTE 舉杯

By Wang, Chung Cheng 王崇政, 2013

SALUTE is inspired by the art of drinking wine. Sculpturally interesting, stylishly modern, the SALUTE is creatively shaped like a wine glass. Enjoy a glass of chardonnay and truly savor every flavor your wine has to offer. Sit at a table that is dramatically lit with SALUTE, enjoy the visible feast in front of you. C'est la vie!

來，一齊舉杯！輕啜甘醇香甜的美酒，享受由不同原料奏鳴出的交響樂，人生，夫復何求？舉杯以酒杯的造型為發想基底，試圖調配出異材質間所蘊藏的新可能，挑戰全新視覺饗宴，Salute！



copper

shiny brass

chrome

clear glass

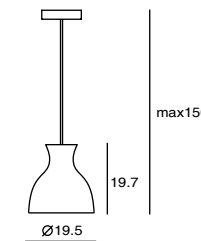

Salute Pendant Wine
SQ-826P
E27 1 x Max 46W
Black textile wire

Materials : mouth-blown glass
Color : clear glass
Canopy : Type A, matt black
Back Plate : Type A

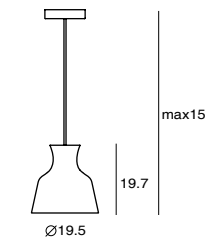

Salute Pendant Cake
SQ-828P
E27 1 x Max 46W
Black textile wire

Materials : mouth-blown glass
Color : clear glass
Canopy : Type A, matt black
Back Plate : Type A

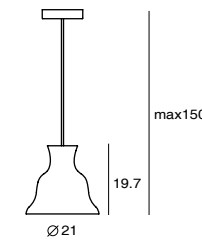

Salute Pendant Bell
SQ-827P
E27 1 x Max 46W
Black textile wire

Materials : mouth-blown glass
Color : clear glass
Canopy : Type A, matt black
Back Plate : Type A

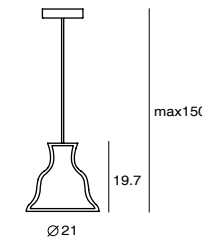

Salute Pendant Bell R
SQ-827PR
E27 1 x Max 46W
Black textile wire

Materials : mouth-blown glass, steel
Color : clear glass + copper
clear glass + shiny brass
clear glass + chrome
Canopy : Type A, matt black
Back Plate : Type A

T1 T1

By Chang, Ting Ting 張滄滄, 2015

Taking the inspirations from classical tube lamps, the young designer Ting Ting gives T1 a chic modern look which utterly plays aesthetics of simplism. With a charming tube-look shade, the T1 is embedded with CRI 90 LED light source, and the protection level is up to IP44 which can be used in zone 2 of bathrooms. It works in both decorative and functional ways. T1 expects to breeze pleasant illumination into spaces.

宛如長笛狀的 T1 出自年輕設計師之手，簡約時尚的外型，不僅為全系列注入活力泉源，同時象徵 SEED 將經典玻璃壁燈重新打造的優雅演繹。無論是床頭燈、浴室或是化妝鏡照明使用，皆能信手捎來迷人的光氛表情，揮灑室內浪漫。



copper



matt brass

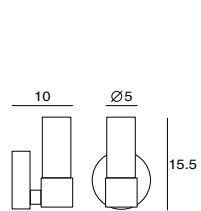

T1 Wall 1
SG-50WB1
G9 1 x Max 40W/ 3W LED

Materials : mouth-blown glass, steel
Color : matt opal + copper
matt opal + matt brass
Canopy : Type A45, same as shade color
Back Plate : Type A28

IP 44

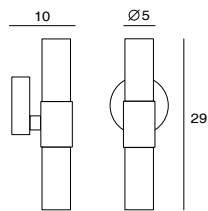

T1 Wall 2
SG-50WB2
G9 2 x Max 40W/ 3W LED

Materials : mouth-blown glass, steel
Color : matt opal + copper
matt opal + matt brass
Canopy : Type A46, same as shade color
Back Plate : Type A28

IP 44



TICKTOCK 滴答

By Chen, Chao Cheng 陳昭成, 2007

TICKTOCK got the inspiration from the concept of time. Without any hesitation, time is constantly moving forward second by second. Creating sculptural geometry, TICKTOCK is coated with sleek matte black paint, and connected to a power source by a red textile cord. The strategic usage of LED makes this modern lighting environmentally sound as well.

時間總是一步步，毫不猶豫且永不回頭地往前走，而「滴答」就像陪您工作到 6:15 的好朋友。霧黑烤漆的低調外型，以紅色紡織線點綴，為冷峻的 TICKTOCK 注入一股暖意，LED 的使用，更賦予這盞簡單的閱讀燈一個不簡單的綠色使命。

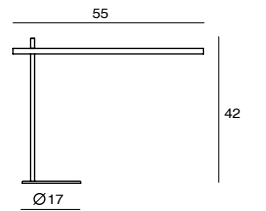

Ticktock Table
SLD-393DP6
LED 6 x 1W (3000K, CRI80, 540lm)
Push on/off switch
adaptor driver
Red textile cord

Materials : aluminum, steel
Color : matt black



ZHE 柘

By Li, Hui Lun 李慧倫, 2011

ZHE is inspired by a wood from the Orient that is as hard as rock. The metal lampshade is meticulously and painlessly hand welded to resemble a cluster of rocks together. The wooden stoppers under each frosted diffuser not only introduce the warm elements of wood, but functionally it softens up the overall light source. ZHE exemplifies illumination on a grand scale.

手工焊接而成的燈罩，表現出如同石頭風化後的果斷線條，帶來不同角度的光影變化。櫟木軸心的木紋，將大自然的鬼斧神工融入其中。「柘」結合了人類與自然的工藝，然後，用光來串接，霧面玻璃柔化了刺眼的光線。



matt black



matt white

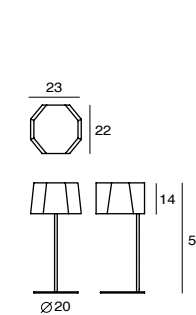

Zhe Table
SQ-2322MD
E27 1 x Max 46W
Red textile cord

Material : steel
Color : matt black

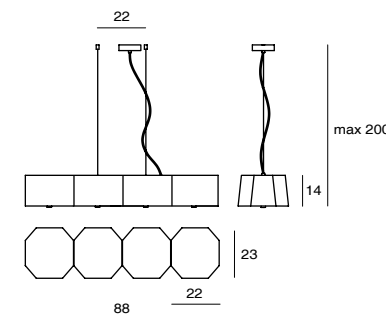



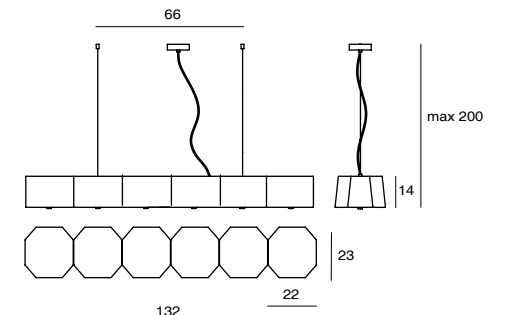

Zhe Pendant P4
SQ-2322MPL4
E27 4 x Max 46W
Black textile wire





Materials : steel, glass, wood
Color : matt black
matt white
Canopy : Type A, same as shade color
Back Plate : Type A

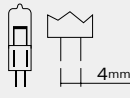
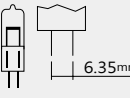

Zhe Pendant P6
SQ-2322MPL6
E27 6 x Max 46W
Black textile wire

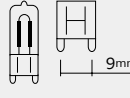











Materials : steel, glass, wood
Color : matt black
matt white
Canopy : Type A23, same as shade color
Back Plate : Type A6











Lamp type	Picture	Lamp feature	Application
LED Built-in		<p>Luminous efficacy: 50-90lm/ w Lifespan: 20,000-50,000 Hrs CRI: 80-90 Color temperature: 3000K (in Seed system for residential) Replaceable: No Dimmable: depends on lamp</p> <p>Thanks to the advantages of high luminous efficacy, lower heat and longer lifespan, built-in LED is widely used in regions with warm weather and places in which are uneasy to replace bulbs. However, it may have light depreciation after using for a while due to imperfect design of LED heat dissipation.</p>	DORA, FORTRESS, MUMU, PLANET, QIN, STREAM, T1, TICKTOCK, XY
LED Retrofit		<p>Luminous efficacy: 50-80lm/ w Lifespan: 15,000-40,000 Hrs CRI: 70-80 Color temperature: 2700K or 4000K Replaceable: Yes Dimmable: depends on bulb</p> <p>LED retrofit bulb was designed to replace conventional incandescent bulb. It comes the advantage of LED, and fits on E27/ E26/ E14 light fittings simply by replacement. Some bulbs work for present dimmable fittings.</p>	<p>For E14/ E26/ E27 fittings</p> <p>2700K for residential 4000K for workplace</p>
CFL Twist		<p>Luminous efficacy: 40-60lm/ w Lifespan: 6,000-10,000 Hrs CRI: 70-80 Color temperature: 2700K or 4000K Replaceable: Yes Dimmable: depends on bulb</p>	<p>For E14/ E26/ E27 fittings</p> <p>2700K for residential 4000K for workplace</p>
CFL Classic		<p>CFL (Compact Fluorescent Lamp) was designed to replace conventional incandescent bulbs. Usually its size is bigger than equivalent-powered conventional bulb. It fits on E27/ E26/ E14 light fittings simply by replacement. But most of the bulbs cannot work with dimmers on the original fittings.</p>	
G4 Halogen		<p>Luminous efficacy: 15-20lm/ w Lifespan: 2,000 Hrs CRI: 100 Color temperature: 2700K Replaceable: Yes Dimmable: Yes</p>	ICE, STARRY NIGHT, TRANSPARENCE
G6.35 Halogen		<p>Both G4 and G6.35 Halogen bulbs work under 12V-output power through a transformer. Thanks to its mini size, designers can create smaller lamps freely than with E27 bulbs. Its luminance is almost same as sunlight (CRI=100), which reveals the true color of the object, especially food.</p>	

Lamp type	Picture	Lamp feature	Application
G9 Halogen		<p>Luminous efficacy: 15-20lm/ w Lifespan: 2,000 Hrs CRI: 100 Color temperature: 2700K Replaceable: Yes Dimmable: Yes</p> <p>G9 Halogen bulbs work under normal power supply without any transformer. Due to its mini size, the lamp shade is usually smaller than E27 fittings. Its luminance is almost same as sunlight (CRI=100), which reveals the true color of the object, especially food.</p>	CHEVALIER, ETERNITY, KAZOKU, PENSEE, ZEN
E27 Halo Classic		<p>Luminous efficacy: 15-20lm/ w Lifespan: 2,000 Hrs CRI: 100 Color temperature: 2700K Replaceable: Yes Dimmable: Yes</p>	For E14/ E26/ E27 fittings
E14 Halo Classic		<p>This bulb was designed as an alternative to conventional incandescent. Since its CRI performance is similar to the sunlight, it accurately presents the color of objects and being broadly used in restaurants.</p>	
PAR30 Spot		<p>Lifespan: 2,000 Hrs CRI: 100 Color temperature: 2700K Replaceable: Yes Dimmable: Yes</p>	TITTO, MIST, SALUTE
R80 Spot		<p>R80 is one of the reflector bulbs/ spot light with high luminance efficiency. Its beam angle is usually narrow and concentrated. Because of its high CRI performance the bulb precisely reveals the color of objects, especially food.</p>	

PRODUCT SPECIFICATIONS

產品規格

系列 Collection	名稱 Product	標配光源 Rating bulb	淨重 (kg)	壁蓋 Canopy	壁鐵 Plate	防護等級 Class
 APOLLO 阿波羅	APOLLO F	LED 17W (2700K, CRI 90, 1360lm)	8.5			II
	APOLLO P	LED 21W (2700K, CRI 90, 1680lm)	4.3	A40	A23	II
 ARCHER 射手座	ARCHER F	E27 1 x Max 46W	13.2			II
	ARCHER F MEGA	E27 3 x Max 46W	33.5			II
 CARRY 盛	CARRY T	E27 1 x Max 46W	2.3			II
	CARRY F	E27 2 x Max 46W	6.8			II
 CASTLE P 堡壘	CASTLE P Bell XS	E14 1 x Max 25W	1.1	A	A	I
	CASTLE P Bell S	E27 1 x Max 46W	2.5	A	A	I
	CASTLE P Cone XS	E14 1 x Max 25W	1.1	A	A	I
	CASTLE P Cone S	E27 1 x Max 46W	2.3	A	A	I
	CASTLE P XS	G9 1 x Max 25W	0.7	A	A	I
	CASTLE P S	E27 1 x Max 46W	2.0	A	A	I
	CASTLE P M	E27 1 x Max 46W	6.7	A4	B2	I
	CASTLE P L	E27 1 x Max 46W	14.1	A4	B2	I
 CASTLE W 堡壘	CASTLE W S LED	LED 5W (3000K, CRI 90, 440lm)	1.6	B14	C2	II
	CASTLE W R LED	LED 5W (3000K, CRI 90, 440lm)	1.3	B14	C2	II
	CASTLE W S LED OUTDOOR	LED 5W (3000K, CRI 90, 440lm)	1.6	B15	A30	II IP 65
	CASTLE W R LED OUTDOOR	LED 5W (3000K, CRI 90, 440lm)	1.3	B15	A30	II IP 65
 CASTLE ROCK 浮岩	CASTLE ROCK P	E27 1 x Max 46W	4.3	A18	A	I
 CASTLE SWING 搖曳	CASTLE SWING P XS	E14 1 x Max 25W	1.1	A	A	I
	CASTLE SWING P S	E27 1 x Max 46W	2.5	A18	A	I
 CASTLE MERMAID 花嫁	CASTLE MERMAID P S	E27 1 x Max 46W	2.7	A18	A	I
	CASTLE MERMAID P L	E27 1 x Max 46W	3.2	A	A	I
 CHINA 閣	CHINA T	E27 2 x Max 46W	3.7			II
	CHINA F	E27 2 x Max 46W	8.8			II
 CHINA LED 閣	CHINA LED T	LED 18W (2700K, CRI 90, 1900lm)	4.8			III
	CHINA LED F	LED 18W (2700K, CRI 90, 1900lm)	8.3			II
	CHINA LED P	LED 18W (2700K, CRI 90, 1900lm)	2.4	A16	A	II
 CLOUD 雲朵	CLOUD C	LED 30W (2700K, CRI 90, 2400lm)	3.4	A42		II
 CONCOM 相伴	CONCOM W	E14 1 x Max 25W	1.4	N	N	II

系列 Collection	名稱 Product	標配光源 Rating bulb	淨重 (kg)	壁蓋 Canopy	壁鐵 Plate	防護等級 Class
 DAMO 達摩	DAMOT Simple	E27 1 x Max 46W	4.8			II
	DAMO P	E27 2 x Max 46W	2.8	A	A	II
 DOBI 多比	DOBIT	E14 1 x Max 25W	1.3			II
	DOBI W	E14 1 x Max 25W	0.6	A22	A6	II
	DOBI P	E14 1 x Max 25W	0.9	A	A	I
	DOBI PR-1	E14 1 x Max 25W	0.9	A23	A6	I
	DOBI PR-70	E14 1 x Max 25W	1.1	A23	A6	I
	DOBI PR-120	E14 1 x Max 25W	1.2	A23	A6	I
	DOBI P6	E14 6 x Max 25W	3.1	A	A	I
	DOBI P10	E14 10 x Max 25W	5.4	A11	B2	I
 DODO 嘟嘟鳥	DODO F	E27 1 x Max 46W	3.7			II
	DODO P	E27 1 x Max 46W	1.2	A	A	I
 DOME 蒼穹	DOME P M	E27 1 x Max 46W	2.4	A	A	I
	DOME P L	E27 1 x Max 46W	4.2	A	A	I
 DORA 朵拉	DORA W	LED 1 x 6.5W (3000K, CRI 90, 550lm)	1.3	A53	B3	III
	DORA P1	LED 1 x 6.5W (3000K, CRI 90, 550lm)	1.2	A24	A6	II
	DORA P3	LED 3 x 6.5W (3000K, CRI 90, 1650lm)	3.6	A13	A8	II
	DORA PL5	LED 5 x 6.5W (3000K, CRI 90, 2750lm)	6.5	R1	R1	II
	DORA P8	LED 8 x 6.5W (3000K, CRI 90, 4400lm)	12.8	A26	A16	II
	DORA PC8	LED 8 x 6.5W (3000K, CRI 90, 4400lm)	13.4	A26	A16	II
	DORA P12	LED 12 x 6.5W (3000K, CRI 90, 6600lm)	19.9	R2	R2	II
	DORA PC12	LED 12 x 6.5W (3000K, CRI 90, 6600lm)	20.8	R2	R2	II
 GLACIER 冰河	GLACIER W	G9 1 x Max 33W	1.6	D	E1	II
	GLACIER P	G9 1 x Max 33W	1.3	A21	A	I
 HELIO 日晷	HELIO P	E27 1 x Max 46W	0.9	A	A	I
 HERCULES LED 海克力士	HERCULES T	LED 8.6W (3000K, CRI 90, 730lm)	4.8			III
	HERCULES F	LED 12W (3000K, CRI 90, 1020lm)	8.7			III
 ICE 晶采	ICET	G4 1 x Max 10W	1.0			III
	ICE W	G4 2 x Max 10W	1.2	B3	A4	III
	ICE P20	G4 20 x Max 10W	11	A7	A3	II
 JOJO LED 悠悠	JOJO LED P	LED 8.2W (2700K, CRI 90, 675lm)	1.7	A28	A	II
 KAZOKU 家族	KAZOKU	G9 4 x Max 33W	5.2	C5	A1	I

PRODUCT SPECIFICATIONS

產品規格

系列 Collection	名稱 Product	標配光源 Rating bulb	淨重 (kg)	壁蓋 Canopy	壁鐵 Plate	防護等級 Class
LAITO 光	LAITO T	E27 1 x Max 46W	2.0			II
	LAITO W	E27 1 x Max 46W	0.8	B8	A5	II
	LAITO W MEGA	E27 1 x Max 46W	2.7	B11		II
	LAITO P S	E27 1 x Max 46W	0.6	A	A	I
	LAITO P M	E27 1 x Max 46W	0.9	A	A	I
	LAITO P L	E27 1 x Max 46W	1.5	A	A	I
LAITO GENTLE 紳光	LAITO GENTLE T	E14 1 x Max 25W	1.8			II
	LAITO GENTLE W	E14 1 x Max 25W	1.3	A30	B3	II
LAITO MINI 微光	LAITO MINI T	E14 1 x Max 25W	1.4			II
	LAITO MINI W	E14 1 x Max 25W	0.5	A30	A6	II
	LAITO MINI W L	E14 1 x Max 25W	1.4	A14	B4	II
	LAITO MINI P	E14 1 x Max 25W	0.5	A12	A18	I
LAITO OPAL 波光	LAITO OPAL F	E27 1 x Max 46W	4.6			II
	LAITO OPAL W	E14 1 x Max 25W	0.7	A43	B3	II
	LAITO OPAL W L	E14 1 x Max 25W	1.4	A14	B4	II
RE LALU 拉魯	RE LALU T	E27 1 x Max 46W	3.2			II
	RE LALU F	E27 1 x Max 46W	4.7			II
LALU+ 拉魯	LALU+ T	E27 1 x Max 46W	2.8			II
	LALU+ F	E27 1 x Max 46W	4.7			II
	LALU+ PL4	E27 4 x Max 46W	4.8	C5	A1	I
LALU+ LED 拉魯	LALU+ LED W	LED 6 x 5W (2700K CRI 90, 425lm)	0.9	B9	A20	II
	LALU+ LED P6	LED 6 x 5W (2700K CRI 90, 2700lm)	6.3	C8	A1	II
	LALU+ LED P8	LED 8 x 5W (2700K CRI 90, 3600lm)	8.4	A32	A19	II
LING 檯	LING W	LED 6W (3000K, CRI 90, 520lm)	1	A54	B3	II
	LING P S	LED 6W (3000K, CRI 90, 520lm)	1	A39	A6	II
	LING PH	LED 6W (3000K, CRI 90, 520lm)	1.1	A39	A6	II
	LING PV	LED 6W (3000K, CRI 90, 520lm)	1.1	A39	A6	II
	LING PL4	LED 4 x 6W (3000K, CRI 90, 2080lm)	4.8	C11	A25	II
	LING PL6	LED 6 x 6W (3000K, CRI 90, 3120lm)	6.8	C10	A24	II
MIST 嵐	MIST M	E27 R63 1 x Max 50W	1.3	D2	A12	I
	MIST L	E27 R80 1 x Max 50W	2.6	D2	A12	I
MOAI 摩艾	MOAI S	LED 6.5W (3000K, CRI 90, 553lm)	0.95	A39	A6	II
	MOAI M	LED 8.5W (3000K, CRI 90, 720lm)	1.5	A16	A	II
	MOAI L	LED 13W (3000K, CRI 90, 1105lm)	3.5	A16	A	II
MUMU 目木	MUMU W	LED 5.7W (3000K, CRI 90, 400lm)	0.8	B10	E2	II
	MUMU P120	LED 32W (3000K, CRI 90, 2150lm)	2.9	M	A1	II
	MUMU P120D	LED 32W (3000K, CRI 90, 2150lm)	2.9	C9	A21	II
	MUMU P180	LED 48W (3000K, CRI 90, 3800lm)	4.8	C10	A24	II
NEWTON 蘋果	NEWTON P	E27 1 x Max 46W	1.9	A	A	I

系列 Collection	名稱 Product	標配光源 Rating bulb	淨重 (kg)	壁蓋 Canopy	壁鐵 Plate	防護等級 Class
NUMEN 精靈	NUMENT	E27 1 x Max 46W	0.7			II
PENSÉE 思想	PENSÉET	G9 1 x Max 33W	2			II
PLANET 行星	PLANETT	LED 8.6W (3000K, CRI 90, 600lm)	3.6			III
	PLANET F	LED 8.6W (3000K, CRI 90, 600lm)	6.2			III
	PLANET W	LED 8.6W (3000K, CRI 90, 600lm)	2.5	A33	A14	III
QIN 沁	QIN W	LED 5W (3000K, CRI80, 425lm)	0.6	A34	E	II
	QIN P3	E27 3 x Max 46W	1.8	C6	A1	I
SALUTE 舉杯	SALUTE WINE P	E27 1 x Max 46W	0.9	A	A	I
	SALUTE BELL P	E27 1 x Max 46W	1.1	A	A	I
	SALUTE BELL P R	E27 1 x Max 46W	1.4	A	A	I
	SALUTE CAKE P	E27 1 x Max 46W	0.9	A	A	I
SNOWFLAKE 雪花	SNOWFLAKE W	E27 1 x Max 46W	1.5	A	A	I
	SNOWFLAKE P7	E27 7 x Max 46W	9.6	A	A	I
T1	T1 W1	LED 1 x 5W 3000K 451lm CRI90	0.8	A45	A28	I IP44
	T1 W2	LED 1 x 5W 3000K 451lm CRI90	1.0	A46	A28	I IP44
TICKTOCK 滴答	TICKTOCK T	LED 6 x 1W (3000K, CRI80, 540lm)	1.8			III
ZHE 柘	ZHE T	E27 1 x Max 46W	2.8			II
	ZHE P4	E27 4 x Max 46W	7.6	A	A	I
	ZHE P6	E27 6 x Max 46W	10.8	A23	A6	I

CE CE: Lamp approved to be compliant with the European Directives.

ETL ETL: Lamp approved and listed in ETL for North American Area.

IP 65 IP65: Dust-proof luminaire protected against ingress of water jets.

IP 44 IP44: Protection against touching active parts with a 1 mm thick wire and against ingress of splash water.

CLASS I: Lamp of Class I with protective earth connection.

CLASS II: Live parts are equipped with additional protective insulation. Connection of a protective earth conductor is not permitted.

CLASS III: Protection against electric shock is based on use of safety extra low voltage.

CANOPY TYPE

壁 蓋 種 類

A

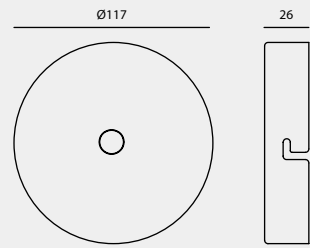

A2

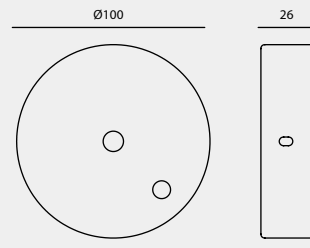

A4

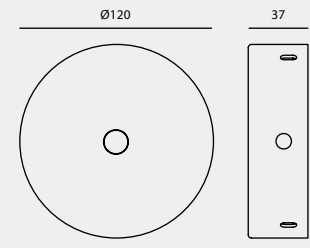

A5

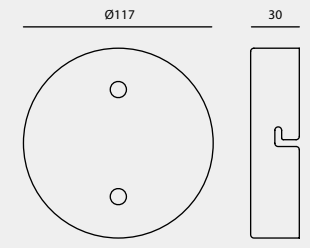

A6

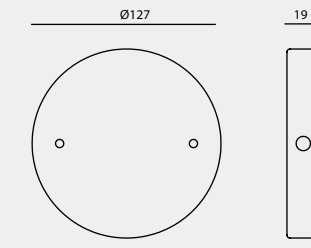

A7

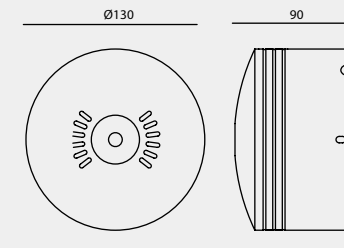

A11

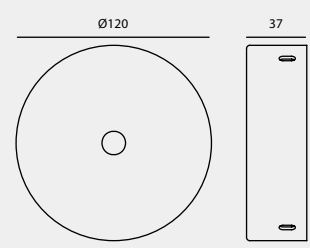

A12

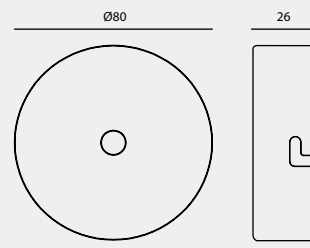

A13

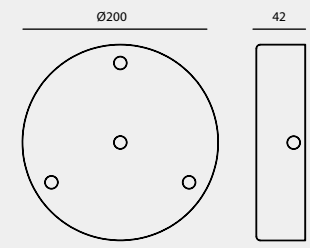

A14

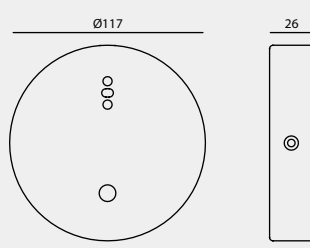

A15

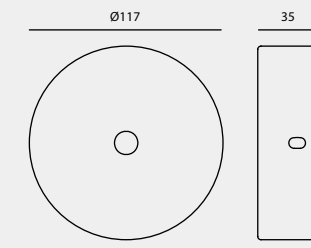

A16

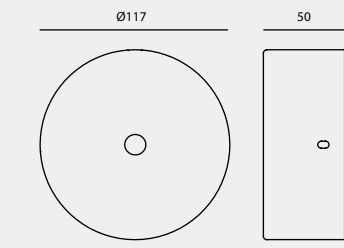

A18

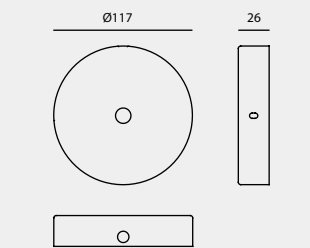

A19

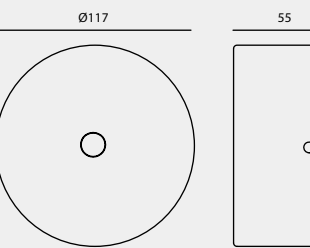

A20

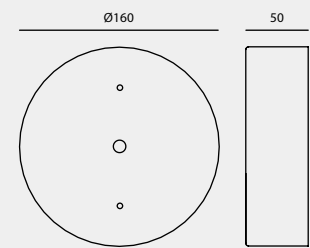

A21

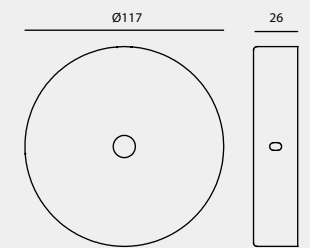

A22

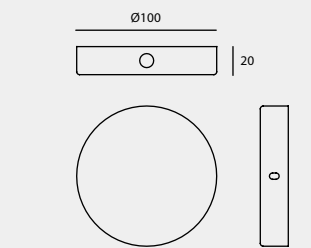

A23

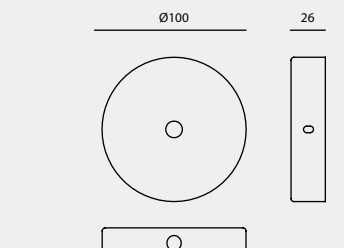

A24

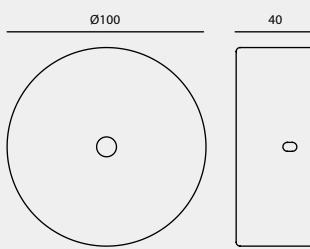

A25

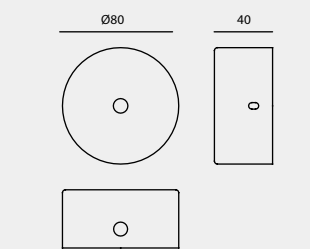

A26

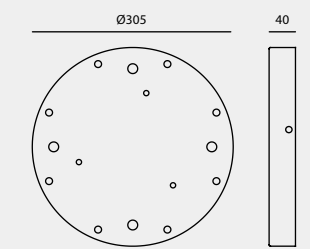

A27

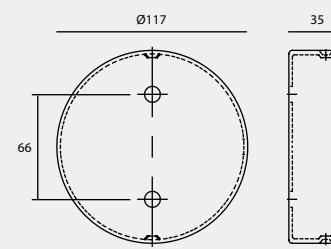

A28

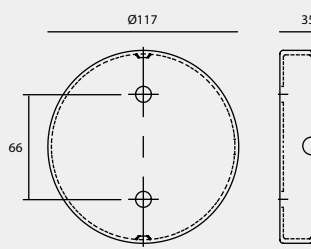

A29

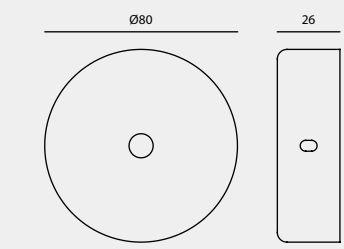

CANOPY TYPE

壁 蓋 種 類

A30

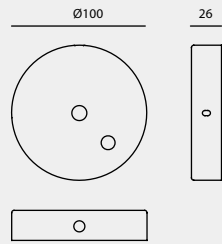

A31

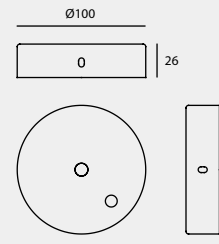

A32

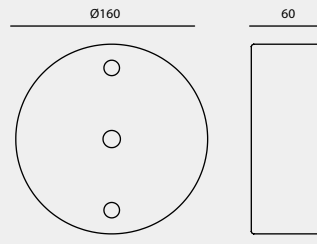

A33

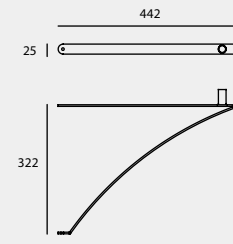

A34

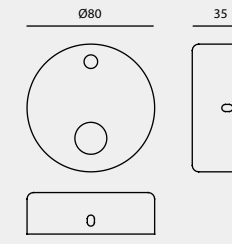

A35

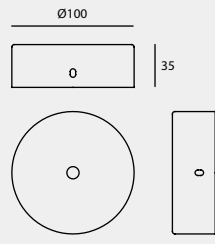

A36

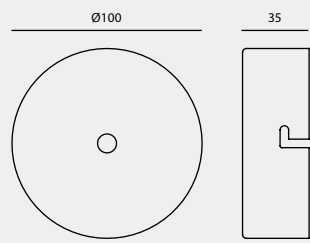

A37

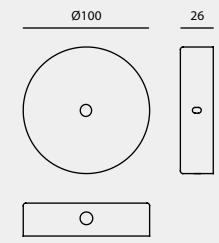

A39

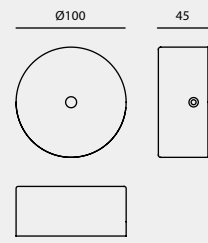

A40

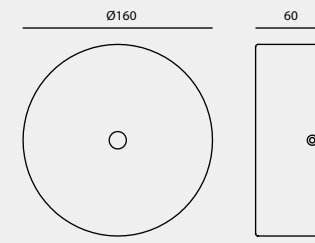

A41

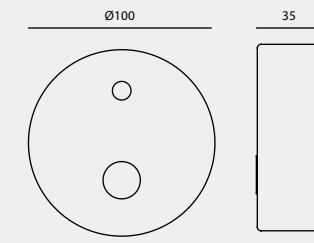

A42

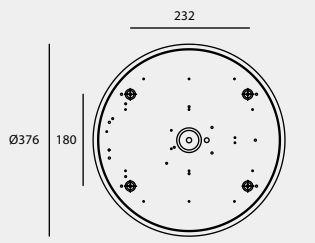

A43

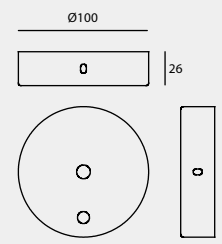

A45

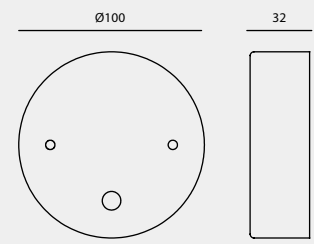

A46

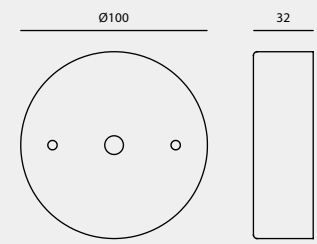

A47

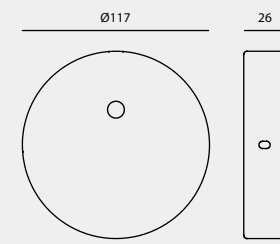

A48

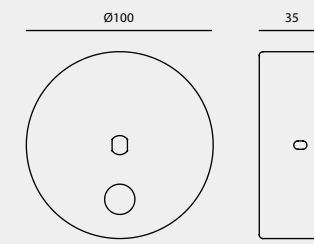

A49

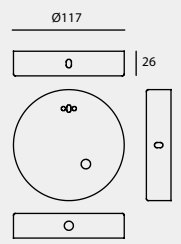

A51

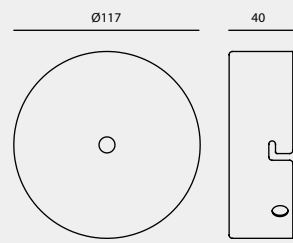

A52

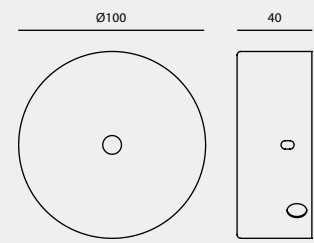

A53

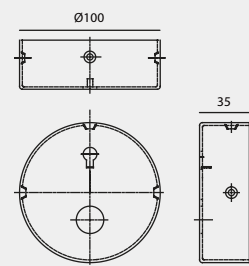

A54

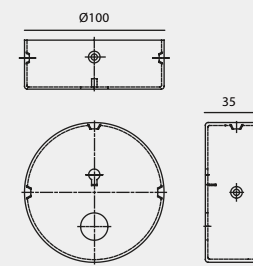

B

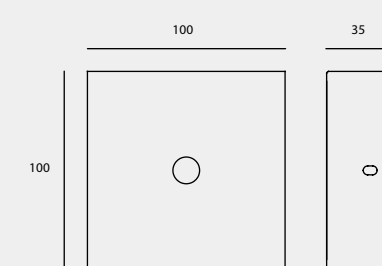

B3

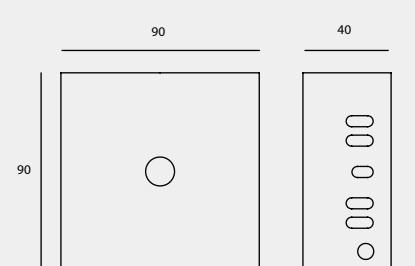

CANOPY TYPE

壁 蓋 種 類

B4

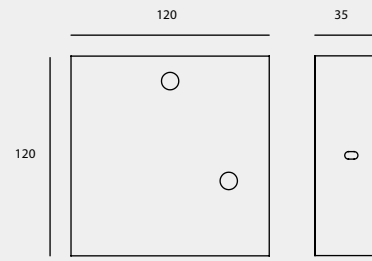

B5

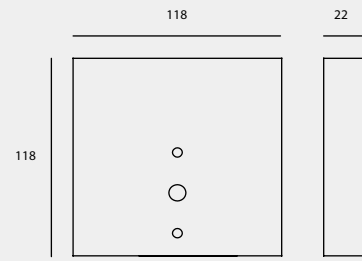

B6

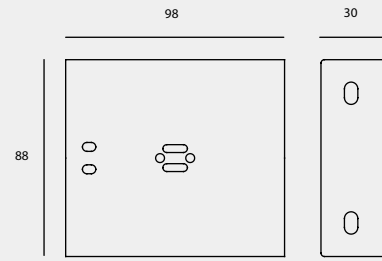

B7

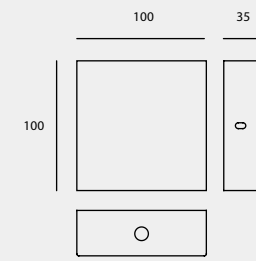

B8

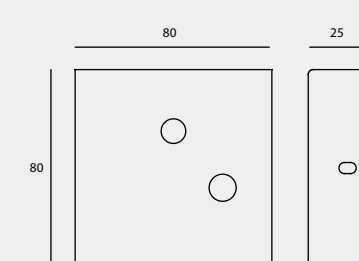

B9

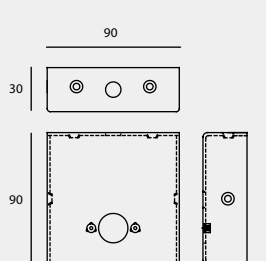

B10

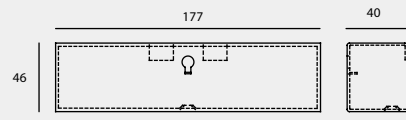

B11

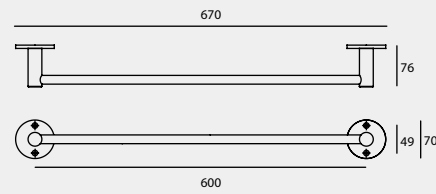

B12

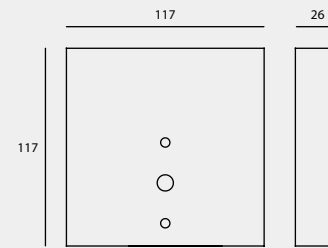

B13

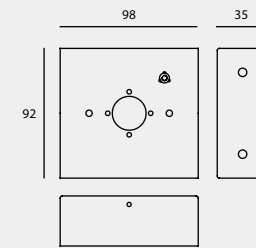

B14

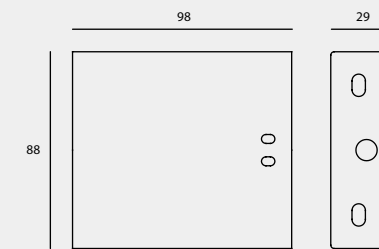

B15

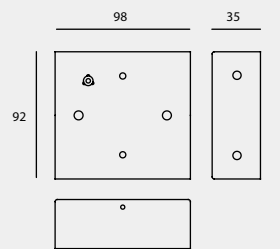

C

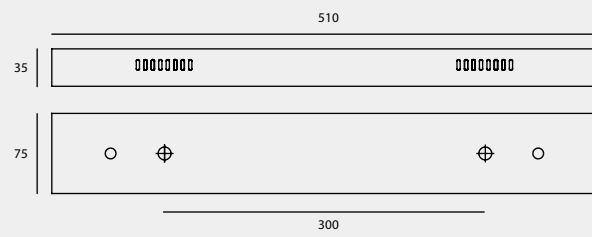

C1

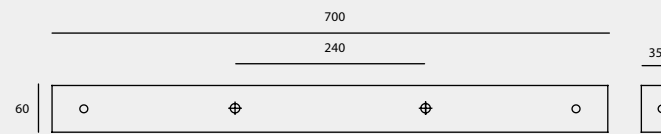

C4

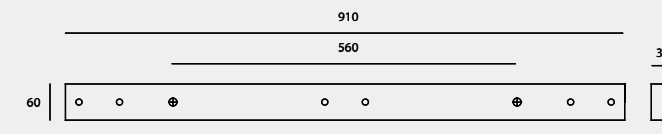

C5

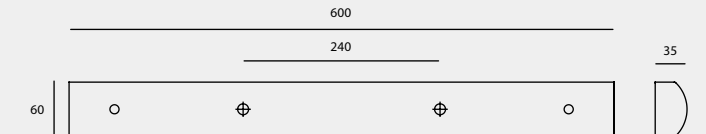

C6

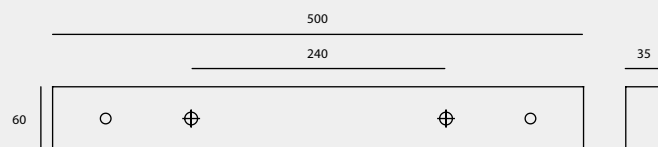

C8

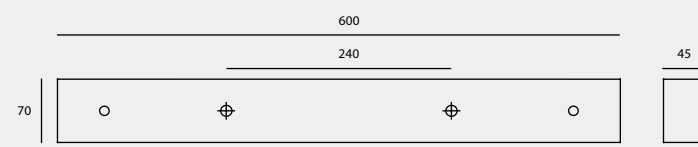

C9

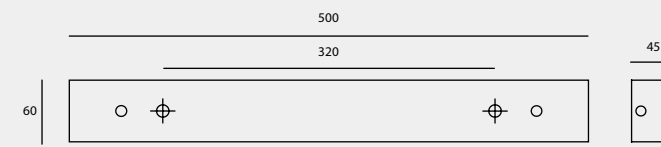

C10

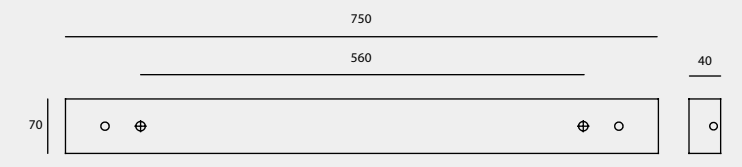

CANOPY TYPE

壁 蓋 種 類

C11

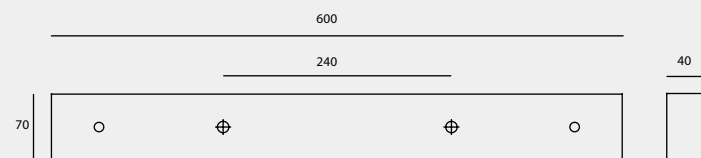

C12

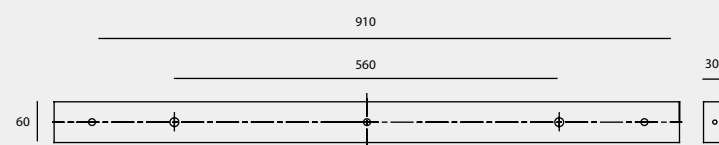

C13

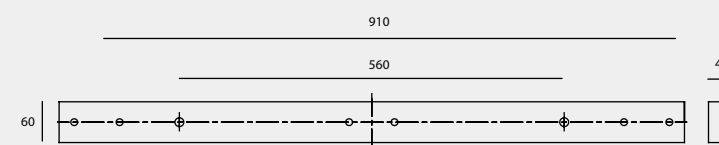

C14

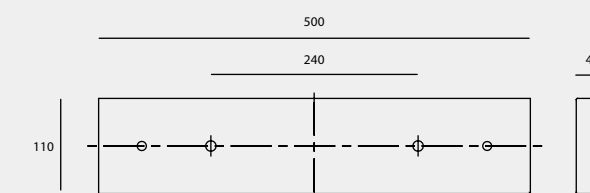

D

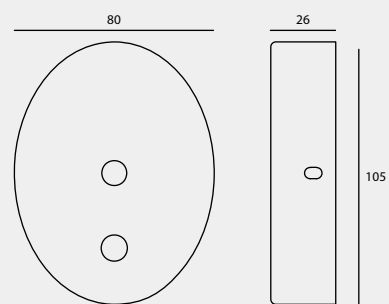

D2

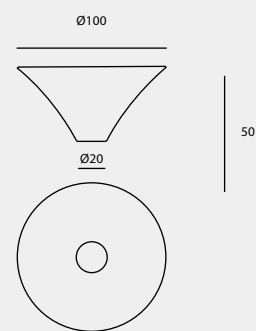

M

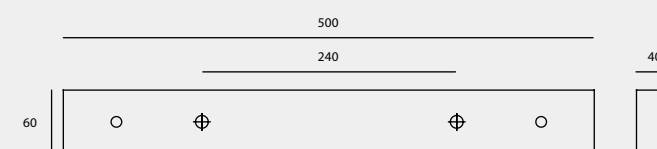

N

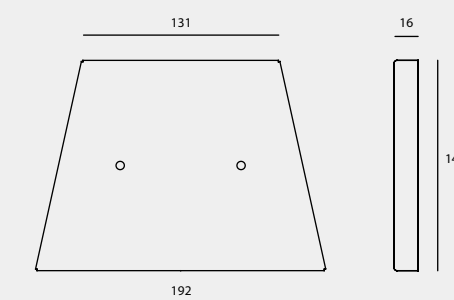

R1

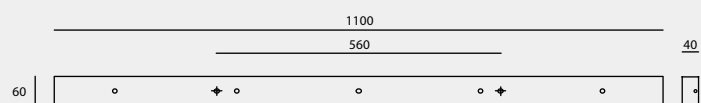

R2

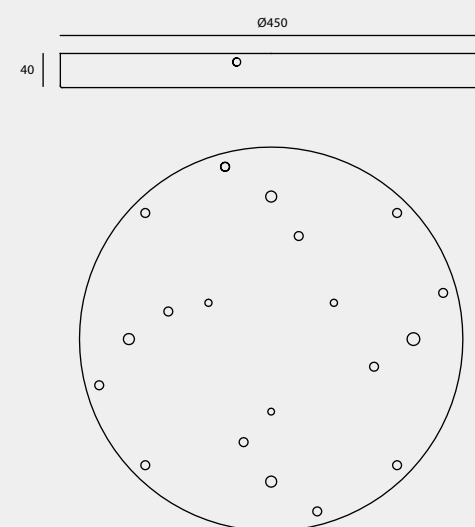

BACK PLATE TYPE

壁 鐵 種 類

A

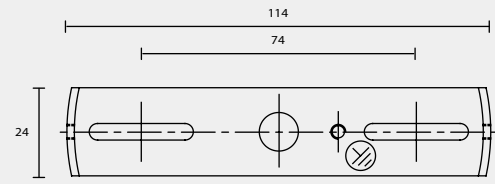

A1

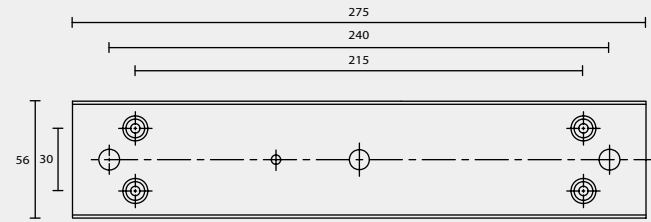

A1-1

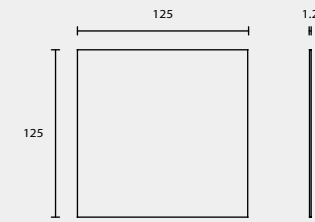

A2

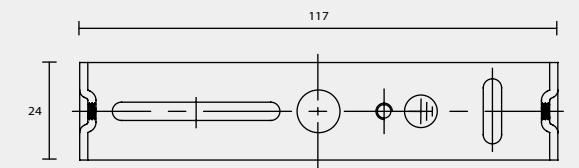

A3

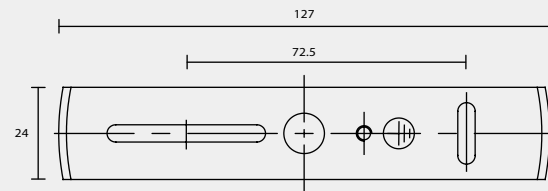

A4

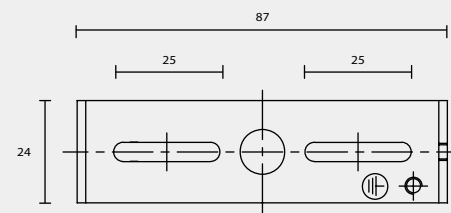

A5

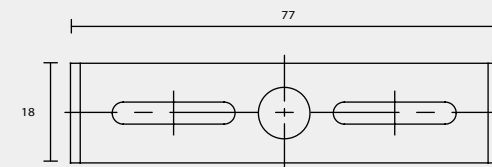

A6

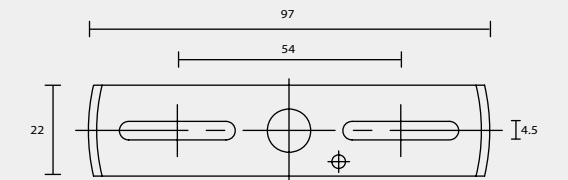

A8

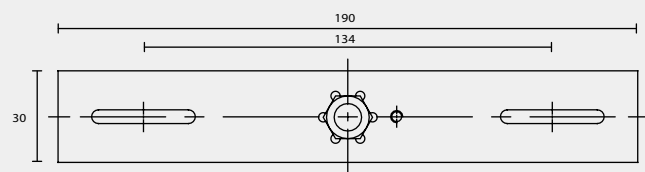

A9

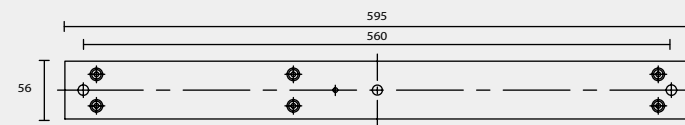

A12

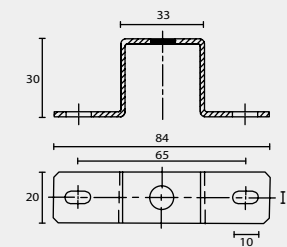

A13

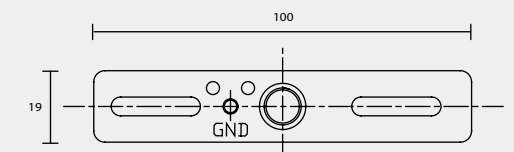

A14

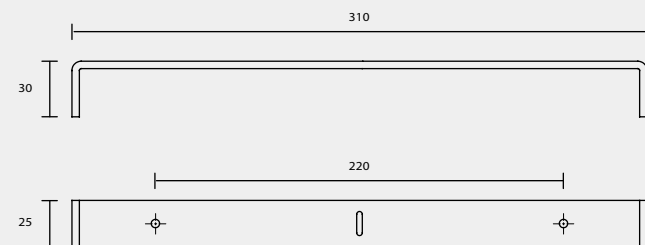

A15

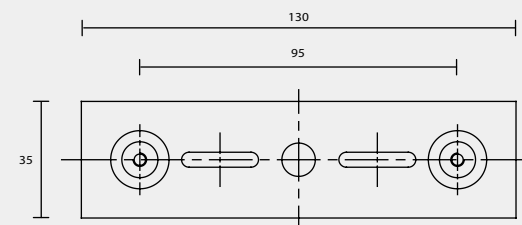

A16

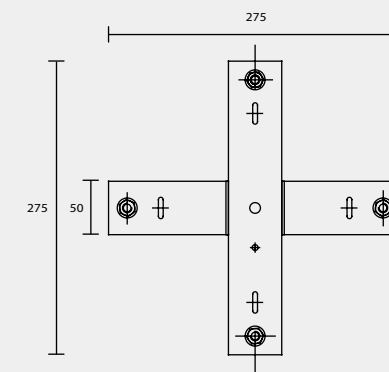

A18

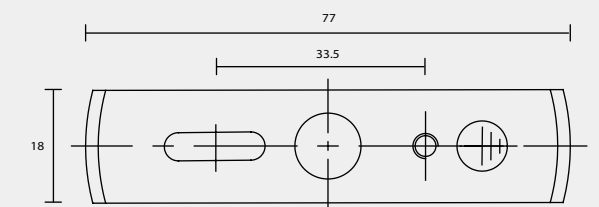

BACK PLATE TYPE

壁 鐵 種 類

A19

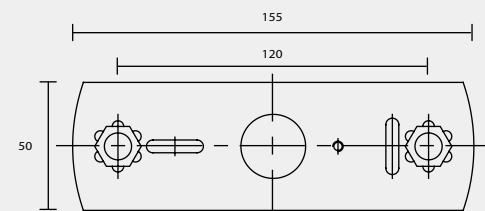

A20

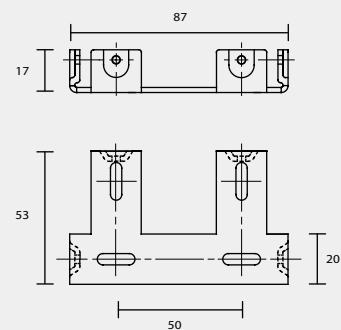

A21

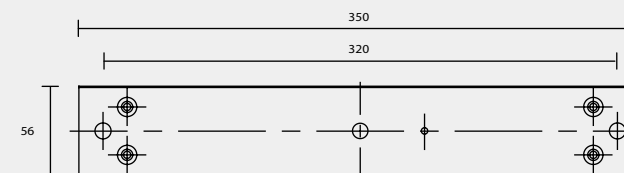

A23

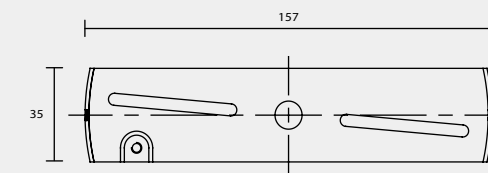

A24

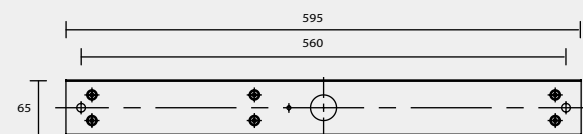

A25

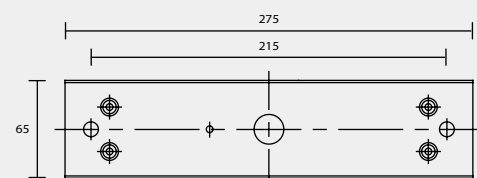

A28

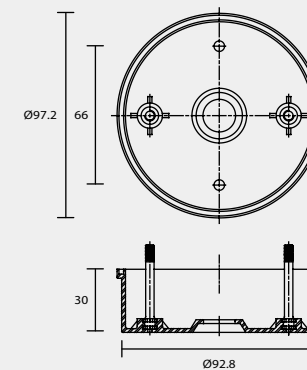

A29

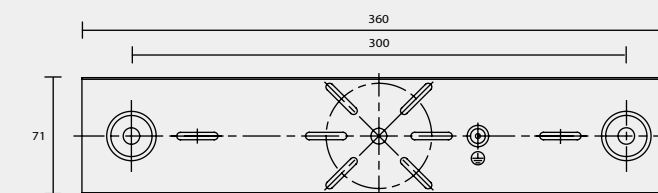

A30

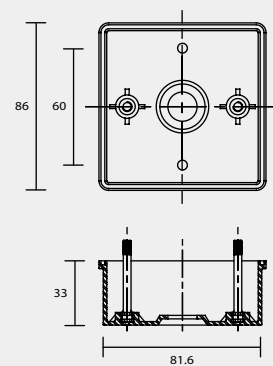

A31

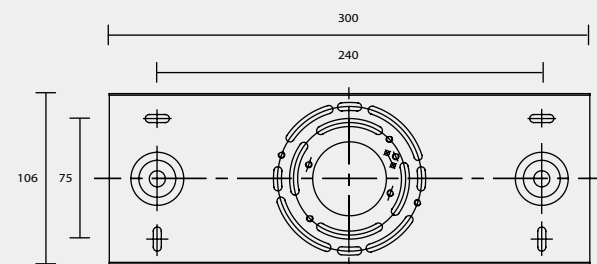

B

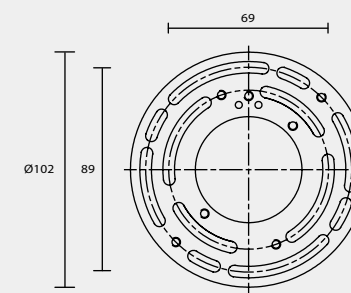

B1

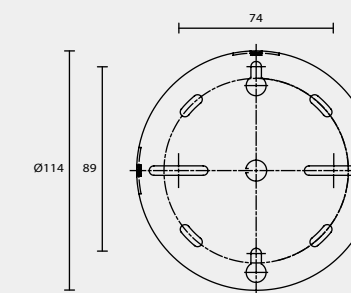

BACK PLATE TYPE

壁鐵種類

B2

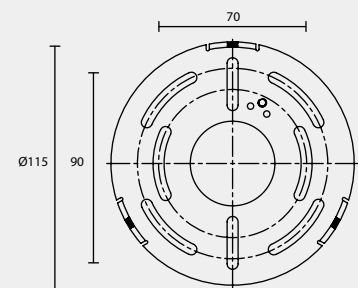

B3

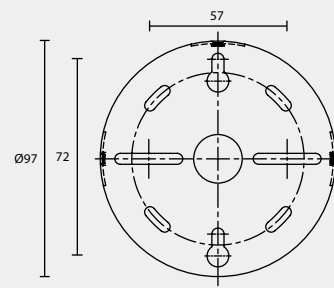

B4

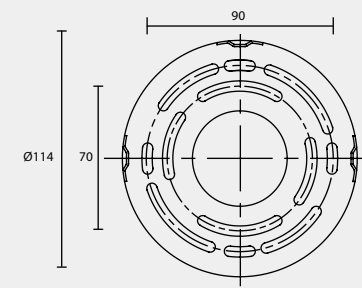

C1

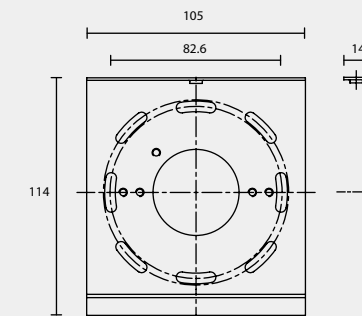

C2

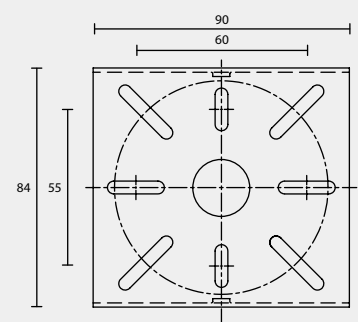

E

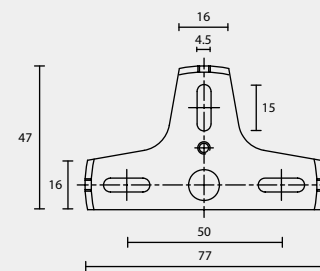

E1

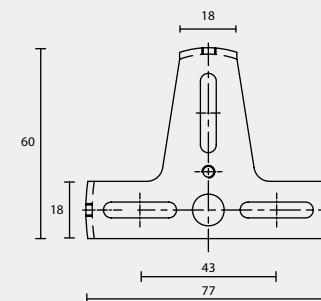

E2

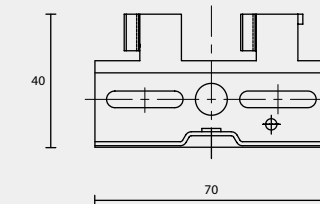

N

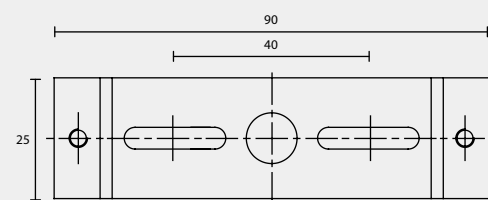

R1

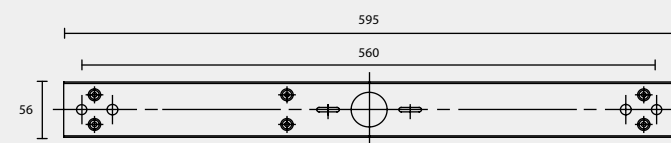

R2

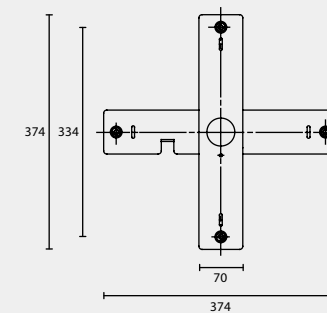

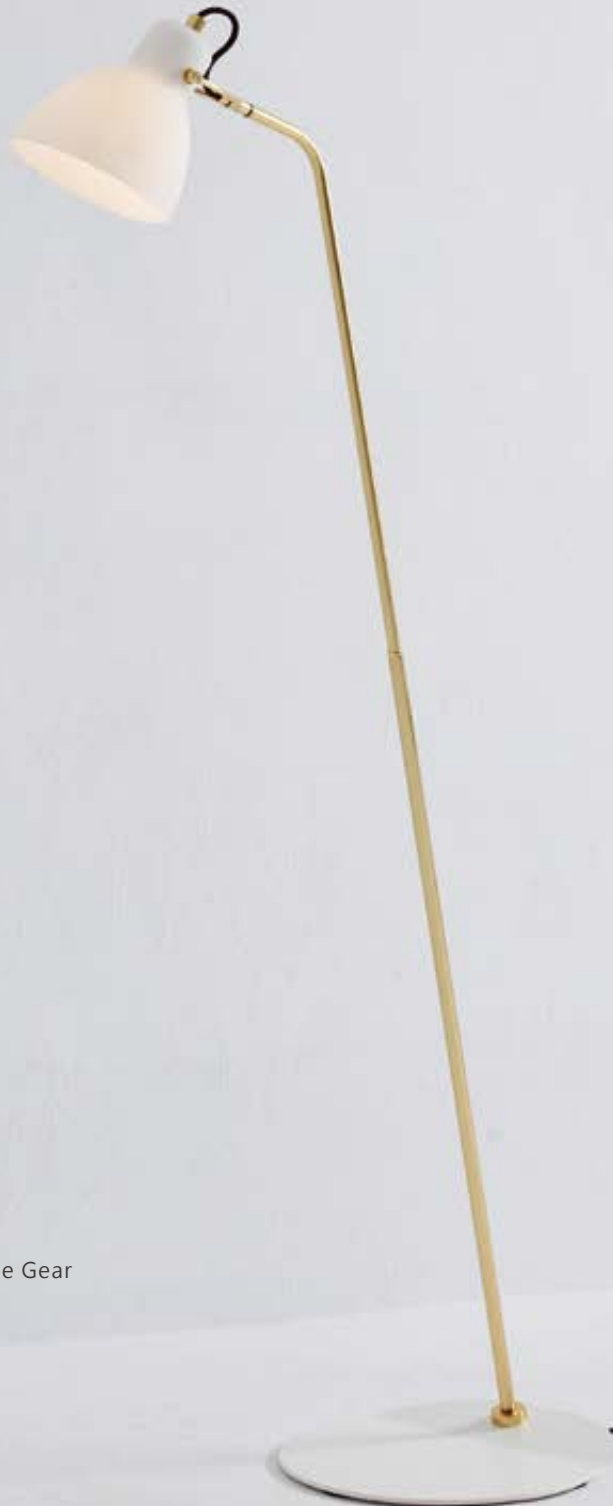

SEED LIGHTING DESIGN CO., LTD.

info@seedlighting.com

www.SeedDesign.tw

73-31, Qionglin S. Rd., Xinzhuang Dist., New Taipei City 242, Taiwan

T. +886 2 2204 6650

F. +886 2 2204 6541

上海据点暨展示中心

seedsh@seedlighting.com

200025 上海市黄浦区打浦桥建国中路10号

T. 021 6113 2524

F. 021 6113 2491

特別感謝 |

太硯設計 卡納設計 蟲點子設計 林果良品松菸概念店 Cafe de Gear



本公司保留為產品進行改善之任何變更且無需提前通知之權利
SEEDDESIGN reserves the right to introduce all changes required for the
improvement of the present product at any time and without prior notice.