



日吾二字意表「日日與吾相會」。WÚ 悉心入微地攜光看顧，與你共覓最契合的生活維度。多元功能簡練收納為一字線條，不論橫軸推展燈體、縱向旋動改變光向，或直覺觸控調整亮度，「日吾」既可沉靜下陪伴佐閱讀需求，亦能投以壁面洗牆，潑灑勻光柔軟夜晚姿態。在拉攏與收靠之間，總能不偏不倚找到適切位置，透出一縷光亮捕捉每一刻相會的時光。

WÚ stands for "daily greeting" in oriental meaning, the considerate design takes care of your daily life.

When light is off and folded back to the rectangle steel niche, it is a good company staying aside quietly with you; When light is needed simply pull it out and handily adjust the light direction catering for multiple purposes, whether it's me-time reading or mood-regulating wall washer, WÚ is always ready to meet you, how good to have a timely WÚ!

By Li, Hui Lun 李慧倫



oatmeal + matt white



sand gold + matt black

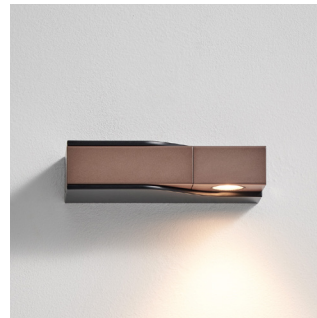

matt pearl cocoa + matt black

Measurement : centimeter / inches

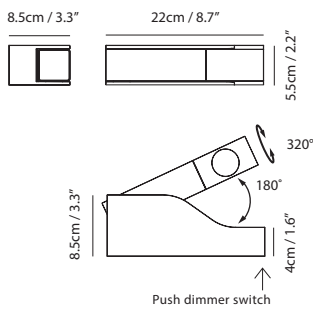

Canopy N3
matt black
matt white

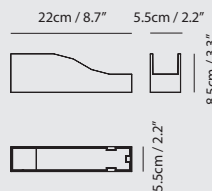

Bracket N3

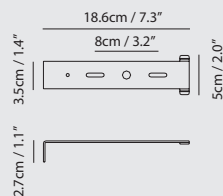

*Lamp center size

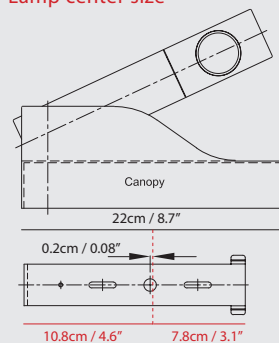

WU Wall

Model
SLD-3980WPE



Material
aluminum, steel

Light Source
LED 1 x 4.5W 2700K CRI95 289lm

Feature
Push dimmer switch

Weight
1.1kg/2.7lb

Color

-  oatmeal + matt white
-  sand gold + matt black
-  matt pearl cocoa + matt black